



# Pactical, Versatile, Cheap Assistive Technology Supports

2<sup>nd</sup> Edition  
5/1/2005



ATEN  
1207 Mellonville Ave  
Sanford, FL 32771  
[www.aten.scps.k12.fl.us](http://www.aten.scps.k12.fl.us)  
(407)688-2201 or (800)328-3678



# Acknowledgements

## Project Facilitators:

First Edition  
Second Edition

Matt Hirn & Donna Jo Kazee  
Matthew Press

## Device Designs:

ATEN would like to thank Matt Hirn and Donna Jo Kazee for their original work on this project. Many of the designs in this book are the product of long hours of creative exploration at the hardware store!

ATEN thanks Cynthia Wheeler for the use of the following designs: *Small Switch Stand*, *Floor Mobile Stand*, and the *Large Switch Stand*. ATEN also acknowledges the use of Cynthia's *Bead Chain* design to develop the *Sensory Stimulation Stand*.

ATEN thanks Carol Parker for the use of the *Number Line* design.

ATEN thanks Linda Burkhart for the design concept of the *Tilting Eye Gaze Frame*.

ATEN thanks Cathy George for her creation of a PVC version of the *Protected Object Display* based on the wood design by Carol Goosens' and Pam Elder

ATEN thanks Jude Dooley and Susan Heaps for their creation of the *multi-purpose easel*.

ATEN thanks Matt Hirn for his creation of the *4 shelf locker organizer* and *Sand/Water Table*.



ATEN  
1207 Mellonville Ave  
Sanford, FL 32771  
[www.aten.scps.k12.fl.us](http://www.aten.scps.k12.fl.us)  
(407)688-2201 or (800)328-3678



**Pactical**  
**Versatile**  
**Cheap**

# Assistive Technology Supports

This publication was developed by the Assistive Technology Educational Network (ATEN) Coordinating Unit, a specialized FDLRS center, fiscally managed by the Seminole County Public Schools; funded through IDEA, Part B, to provide information, training, and technical support in the area of Assistive Technology to Florida students.



ATEN  
1207 Mellonville Ave  
Sanford, FL 32771  
[www.aten.scps.k12.fl.us](http://www.aten.scps.k12.fl.us)  
(407)688-2201 or (800)328-3678



Permission for reprinting this book, with acknowledgement to ATEN, is hereby granted.

## Table of Contents

What is PVC?	1
Safety First	2
The PVC Toolkit	3
Measuring and Cutting	7
Cleaning and Cementing	8
Aesthetics: The Final Touch	9
<b><u>PVC Designs</u></b>	
T Bar/Adapted Writing Aid	11
Adapted Writing Aid	12
Stove Knob Turner	13
Toy Corral	14
Small Switch Stand	15
Large Switch Stand	16
DynaVox Stand	17
Sensory Stimulation Stand	22
Felt Story Board	25
Dual-Angle Easel	28
Adjustable Height Switch Mount	32
Toy Bowling Ball Launcher	35
Number Line	40
Communication Stand	41
Tilting Eye Gaze Frame	42
Circle	44
Auditory Feedback Phone	45
Multi-Purpose Easel	46
Protected Object Display	48
Floor Mobile Stand	49
4 Shelf Locker Organizer	50
Sand/Water Table	51
SCAMMPERR	52
PVC Resources	53



ATEN  
1207 Mellonville Ave  
Sanford, FL 32771  
[www.aten.scps.k12.fl.us](http://www.aten.scps.k12.fl.us)  
(407)688-2201 or (800)328-3678



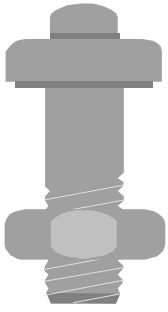

# *What is PVC?*

## **Practical**

Polyvinyl chloride is a thermoplastic resin characterized by light weight, chemical inertness, resistance to weathering, and electrical non-conductivity. These are excellent qualities for one of its major uses, pipe. They are also good qualities for building assistive technology supports.

## **Versatile**

The pipe can be purchased in several diameters and thicknesses or schedules. The thicker the wall of the pipe, the greater the amount of pressure per square inch that it can withstand from liquids within. The two most common schedules available are 1120 and 40. The thicker Schedule 40 pipe is the best choice for most projects.

There are two other grades of PVC pipe: clear and furniture. Clear PVC allows you to see through it, which may be crucial to some projects. Furniture grade differs from regular PVC in three ways:

1. It has titanium dioxide added to it, making it more resistant to ultraviolet light breakdown.
2. It has an impact modifier added to it so that it is less likely to break under pressure.
3. It has a glossy finish.

## **Cheap**

PVC pipe and joint components are widely used in the construction industry. These materials and the tools needed to design and build a wide range of practical, customized devices are readily available. They are also surprisingly inexpensive.



ATEN  
1207 Mellonville Ave  
Sanford, FL 32771  
[www.aten.scps.k12.fl.us](http://www.aten.scps.k12.fl.us)  
(407)688-2201 or (800)328-3678



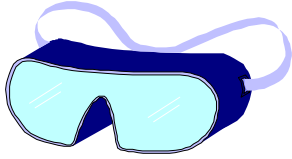

# *Safety First*

1. At all times, ensure that you have adequate ventilation while working with PVC. Open doors and windows and turn on air circulating systems (fans, air conditioning). If you feel dizzy, intoxicated, or develop a headache while working with PVC glue or cleaner, get fresh air immediately. If the symptoms persist, seek medical treatment. Long-term over exposure can cause permanent nervous system damage.
2. PVC cleaner and cement are both flammable. Keep them away from open flame at all times.
3. Do not build weight-supporting devices out of plumbing-grade PVC. Use furniture-grade PVC instead.
4. Avoid sharp, unprotected edges in designs. Use end caps if possible or sand down edges. This results in a safer, more aesthetically pleasing design.
5. Do not work with PVC cleaners and cements during pregnancy. Some people have a strong sensitivity to these chemicals and should avoid them altogether.
6. Always wear dust masks and safety glasses when using power tools, *e.g.*, drills, saws, sanders. It is recommended that you wear safety glasses at all times during PVC work, but especially during cleaning and gluing activities.
7. Test all PVC welds after assembly. Apply a good amount of force to ensure that the cement has set and the bond is sufficient.
8. Get help from an experienced person when you aren't sure what is safe, when something isn't working, or when you have technical questions.
9. To ensure safety, routinely examine your equipment before you begin a project.
10. Know your district policies for PVC glue. Some districts do not allow its use in classrooms.



ATEN  
1207 Mellonville Ave  
Sanford, FL 32771  
[www.aten.scps.k12.fl.us](http://www.aten.scps.k12.fl.us)  
(407)688-2201 or (800)328-3678



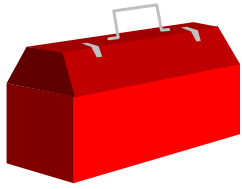

# *The PVC Tool Kit*

The following materials should be included in a basic multi-purpose PVC toolkit. For storage, consider using a heavy-duty toolbox, large fishing tackle box, or plastic shelving units with sliding drawers. Use a notebook or binder to keep track of inventory and design ideas. While the following designs use 1/2" components, PVC pipe and fittings are also available in 1/4", 3/4", 1", and several larger diameters.







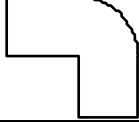
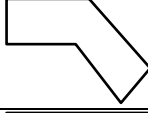

---

## **PVC Toolkit**



ATEN  
1207 Mellonville Ave  
Sanford, FL 32771  
[www.aten.scps.k12.fl.us](http://www.aten.scps.k12.fl.us)  
(407)688-2201 or (800)328-3678

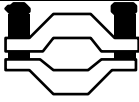

Drawing	Name	Number/ Amount	Use/Comments
	½" diameter PVC pipe	30' (comes in lengths of 10')	Make two sets of pieces, varying by ½" increments in lengths from 1" to 12".
	½" 90° elbows	12	Allows attachment of two PVC pipes at a 90° angle.
	½" 45° elbows	6	Allows attachment of two PVC pipes at a 45° angle.
	½" T joints	12	Allows attachment of three PVC pipes.
	½" straight couplers	6	Increases pipe strength/diameter when attaching to a surface; allows extension of a pipe segment.
	½" female adapters	6	Allows attachment of removable components when used in conjunction with male adapter.
	½" male adapters	6	Allows attachment of removable components when used in conjunction with female adapter; allows direct attachment of a pipe to a metal floor flange.
	½" PVC end cap	12	Covers sharp edges; makes design more aesthetically pleasing.
	Ground clamps	6	Allows attachment of two pipes side-by-side or a pipe to another surface.
	¼" x 2 ½" machine screws	6	Allows attachment of ground clamps to thicker surfaces.

**PVC Toolkit**



ATEN  
 1207 Mellonville Ave  
 Sanford, FL 32771  
[www.aten.scps.k12.fl.us](http://www.aten.scps.k12.fl.us)  
 (407)688-2201 or (800)328-3678



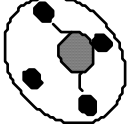
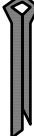
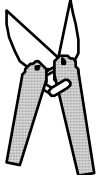
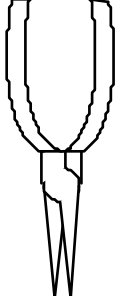
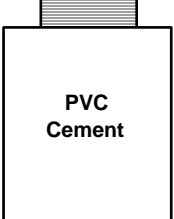
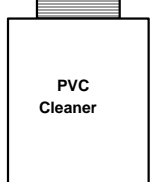
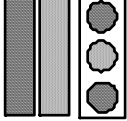



Drawing	Name	Number/ Amount	Use/Comments
	1 ½” stainless steel worm-drive hose clamps	6	Allows attachment of pipes to pipes and other surfaces.
	½” metal floor flange	6	Used as a base for mounting switches.
	Cotter pins	6	Used as part of a removable joint in conjunction with fishing line.
	PVC pipe cutter	1	Used for cutting PVC pipes and components.
	Needle nose pliers or standard pliers	1	Allows easier gripping of small pipe pieces for removal.
 PVC Cement	PVC cement	1	Welds PVC pipes and components together.
 PVC Cleaner	PVC cleaner	1	Removes dirt, writing, and stickers from pipe and components.
	Velcro strips and dots	3 yards	Allows attachment of switches and other items to mounting plates or PVC frame.

**PVC Toolkit**

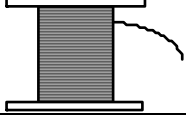
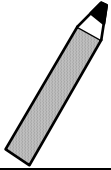
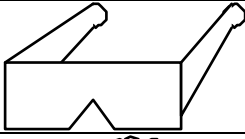
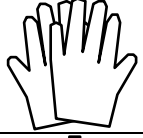

ATEN  
 1207 Mellonville Ave  
 Sanford, FL 32771  
[www.aten.scps.k12.fl.us](http://www.aten.scps.k12.fl.us)  
 (407)688-2201 or (800)328-3678

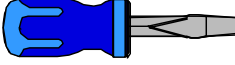

Drawing	Name	Number/ Amount	Use/Comments
	Cable ties	1 package	Allows attachment of pipes to surfaces; especially useful for temporary or mock-up purposes.
	Braided nylon cord or fishing line		Used in conjunction with cotter pins to make a removable joint.
	Grease pencil	2	Used to mark cutting measurements and indicate attachment points on pipes.
	Safety glasses	1	Used while drilling or cutting pipe, applying chemicals to pipe, and during painting.
	Gloves	1 set	Used while applying chemicals to pipe and during painting.
	Spray paint	1 can	Used to protect pipe and improve aesthetics.
	Screw driver	1 standard	Used to fasten hose clamps.
	Heat-shrink wrap		Used to protect pipe and improve aesthetics.

**Additional Items:**

The following items are useful additions to your tool box, but are not necessary for most projects:

- Battery-operated or corded drill
- Hack saw
- Hot glue gun
- Sand paper or emery cloth
- Fine metal files: flat and round
- Heat gun
- Locking adjustable pliers



ATEN  
 1207 Mellonville Ave  
 Sanford, FL 32771  
[www.aten.scps.k12.fl.us](http://www.aten.scps.k12.fl.us)  
 (407)688-2201 or (800)328-3678





# *Measuring & Cutting*

Make accurate cuts by checking your measurements twice before cutting. When designing or copying an existing design, be sure to account for the pipe length used for the joints. Each joint will take  $\frac{5}{8}$ - $\frac{3}{4}$ " of pipe on each side, depending on how firmly you join the parts together. End caps use  $\frac{3}{4}$ " of pipe. A "T" joint will add an additional  $1\frac{3}{8}$ " to a pipe.

Plan your cuts in advance so that you have the least amount of waste material possible. For increased accuracy, cut with the PVC cutter blade above the pipe so you can see where the blade comes into contact with the pipe. Placing a  $\frac{1}{2}$ " paper tube over the pipe and holding it in place at the desired length can be a helpful way to line up a cut. The tube can be made by cutting a strip of paper, wrapping it around a  $\frac{1}{2}$ " diameter pipe, and taping the paper so that it retains its tube shape.

Squeeze and release the cutter several times if necessary to start the cut. Release the cutter after each squeeze to engage the ratcheting effect. If the pipe fractures when you start to cut it, move further down the pipe and start again. Using a fractured pipe could cause a crooked joint or failure of the joint.



ATEN  
1207 Mellonville Ave  
Sanford, FL 32771  
[www.aten.scps.k12.fl.us](http://www.aten.scps.k12.fl.us)  
(407)688-2201 or (800)328-3678



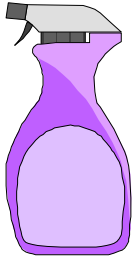

# *Cleaning & Cementing*

There are a variety of cements and cleaners that can be used with PVC pipe. For aesthetic reasons it is best to choose one that does not have a dye in it. It can not be stressed enough that proper ventilation is required when working with PVC. Failure to provide proper ventilation can result in over exposure. Please read and follow the recommendations in the **Safety First** section of this book before undertaking any project using PVC.

When using an angle other than 90 degrees with a T joint, mark the joint with a grease pencil while it is in the proper position before cementing. By lining up the grease pencil line after gluing, the joint will be in the proper alignment. This procedure is explained in further detail later in this book, within the directions of the projects that require its use.

It is a good idea to pre-fit all projects or assemblies prior to cementing the components to confirm size and fit.

Apply the cleaner to both surfaces to be joined first. Then apply the cement to both the pipe and the inside of the joint. You will have about twenty seconds to work before the cement sets. Use a half turn motion when joining the parts to ensure the best bond.

After pressing the pieces all the way together, make sure the union is straight by placing the pipe on a flat surface and pressing the joints so that they are flush with the surface.



ATEN  
1207 Mellonville Ave  
Sanford, FL 32771  
[www.aten.scps.k12.fl.us](http://www.aten.scps.k12.fl.us)  
(407)688-2201 or (800)328-3678





# *Aesthetics: The Final Touch*

You may want to improve the appearance of your PVC projects by painting them. The advantage to painting is that it offers some protection from UV light deterioration. The drawbacks are that it is time consuming, scratches easily, and increases the final cost of the project. If the PVC project is to be painted, a spray paint is recommended. The paint will perform better if a coat of primer is applied first. The paint will also resist scratching better if given a few weeks to cure before using the project.

Colored shrink wrap, such as is used in the electrical trade, can be applied to provide a more durable finish than paint. Shrink wrap is applied to the pipe during the construction, since it must be slipped over the pipe. A heat gun is used to apply heat and shrink the wrap to the pipe. This finishing method is somewhat costly. Check with your local electrical supply store to determine the cost and availability of heat shrink materials in your area.



ATEN  
1207 Mellonville Ave  
Sanford, FL 32771  
[www.aten.scps.k12.fl.us](http://www.aten.scps.k12.fl.us)  
(407)688-2201 or (800)328-3678



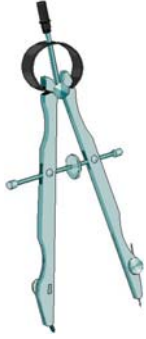

# *PVC Designs*

The following designs have been used in the ATEN workshop on PVC. They range in complexity and the level of skill required. Every device has been used in the field.

We invite you to think of these designs and the basic skills you'll master as you build them as a foundation for developing your own devices that are tailored to the specific needs of the children you serve.

If there is an idea in the book that you like, but you are not able to use that exact design then SCAMMPERR. Look forward to the end of this book, where you can gain ideas on how to modify any design to meet your individual needs.

As you begin to explore the uses of PVC devices, please send us your plans and your comments.



ATEN  
1207 Mellonville Ave  
Sanford, FL 32771  
[www.aten.scps.k12.fl.us](http://www.aten.scps.k12.fl.us)  
(407)688-2201 or (800)328-3678



# PVC Design: T Bar/Adapted Writing Aid

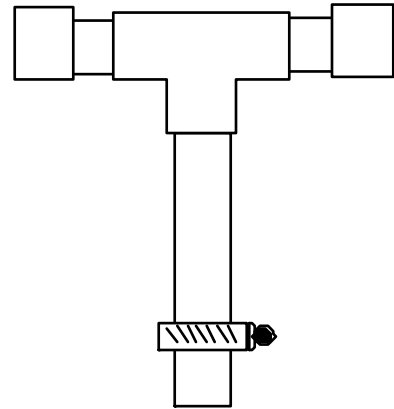

## Parts:

½" PVC pipe:

One 5" piece

Two 2 ¼" pieces

One ½" PVC T joint

Two ½" PVC end caps

One 1 ½" stainless steel worm drive clamp (for attaching pencil or other writing implement)

## Tools/Supplies

Pliers

PVC cutters

PVC cement

PVC cleaner

Tape measure

## Assembly Instructions:

1. Use the PVC cutters to cut two 2 ¼" pieces and one 5" piece of PVC pipe.
2. Assemble the T bar to assure proper fit and alignment.
3. Take the T bar apart one joint at a time using the pliers as necessary. Apply PVC cleaner and cement, then reassemble the joint before taking apart the next one.
4. Use the worm drive clamp to attach writing or pointing device to the 5" piece of PVC pipe.

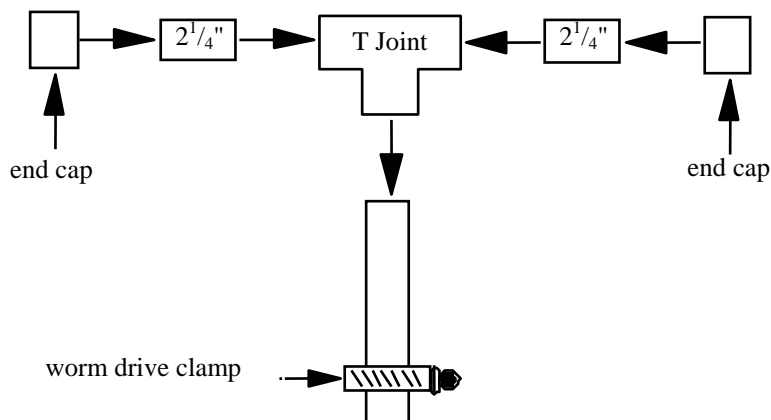

ATEN  
1207 Mellonville Ave  
Sanford, FL 32771  
[www.aten.scps.k12.fl.us](http://www.aten.scps.k12.fl.us)  
(407)688-2201 or (800)328-3678



# PVC Design: Adapted Writing Aid

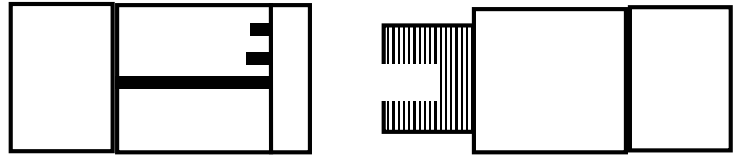

## Parts:

1/2" PVC pipe:

Two 1 1/2" pieces

One 1/2" PVC male threaded adapter

One 1/2" PVC female threaded adapter

Two 1/2" PVC end caps

## Tools/Supplies:

Pliers

PVC cutters

PVC cleaner

PVC cement

Hacksaw

Tape measure

Grease pencil

Vise

## Assembly Instructions:

1. Use the PVC cutters to cut two 1 1/2" pieces of PVC pipe.
2. Preassemble the components to assure proper fit.
3. Separate the writing aid into two parts by unscrewing it at the middle. Use the grease pencil to mark a 3/8" wide slot on the threaded end of the male threaded adapter. Secure the male threaded adapter in a vise and cut the slot using a hacksaw. Cut to the depth of the last two threads. Bend the slot material outward to snap it off at the base.
4. Disassemble one joint at a time using the pliers if necessary.
5. Use the PVC cleaner and cement to assemble the parts as shown.
6. Screw the two halves together with writing/drawing/painting tool inserted in the area cut out by hack saw. Tighten until tool does not move.

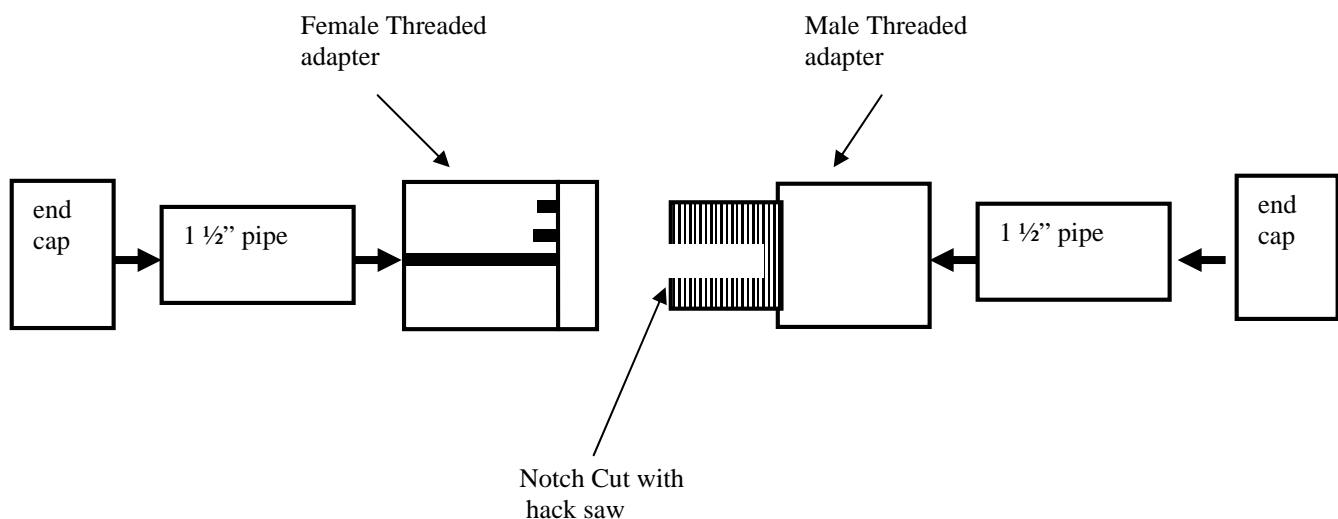

ATEN  
1207 Mellonville Ave  
Sanford, FL 32771  
[www.aten.scps.k12.fl.us](http://www.aten.scps.k12.fl.us)  
(407)688-2201 or (800)328-3678



# PVC Design: Stove Knob Turner

## Parts:

- ½" PVC pipe:
  - One 23" piece\*
  - Two 1 ¼" pieces
- One ½" PVC T joint
- Two ½" PVC end caps

\*length customized based on student's needs.

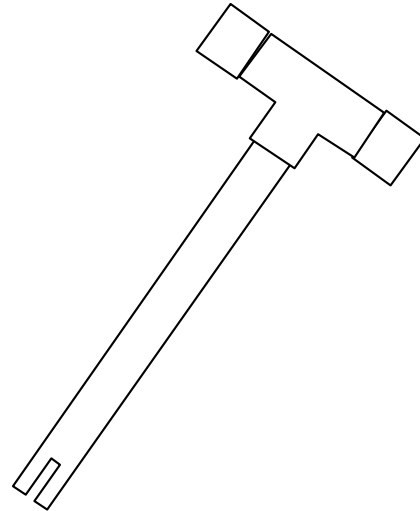

## Tools/Supplies:

- |               |              |
|---------------|--------------|
| Pliers        | PVC cutters  |
| PVC cement    | PVC cleaner  |
| Hack saw      | Tape measure |
| Grease pencil | Vise         |

## Assembly Instructions:

1. Use the PVC cutters to cut two 1 ¼" pieces and one 23" piece of PVC pipe.
2. Assemble the stove knob turner to assure proper fit and alignment of parts.
3. Use the tape measure and grease pencil to mark a notch in the exposed end of the 23" piece of PVC pipe. The dimensions of the stove knob will determine the size of the notch.
4. Place the 23" piece of PVC in the vise and use the hack saw to cut the notch. Bend the notch material outward to break it off of the pipe. Remove pipe from vise.
5. Cement the 23" piece of PVC pipe to the T joint, applying PVC cleaner and cement to both pieces. Use the pliers as necessary to take apart the remaining joints, one at a time, apply cleaner and cement, then reassemble them.

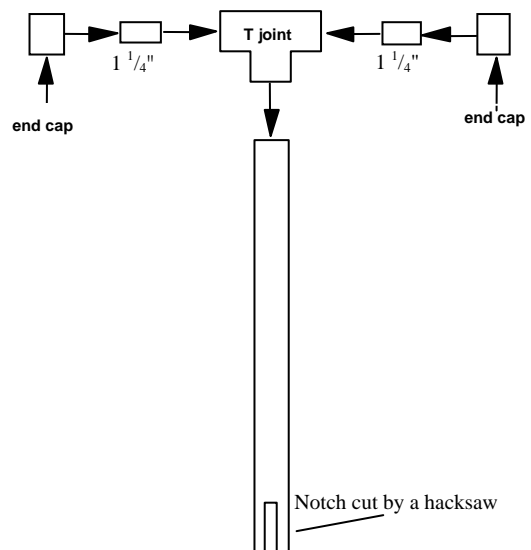

# PVC Design: Toy Corral

## Parts:

½" PVC pipe:

Eight 12" pieces\*

Eight ½" PVC 45° elbows

## Tools/Supplies:

Pliers

PVC cutters

PVC cement

PVC cleaner

Tape measure

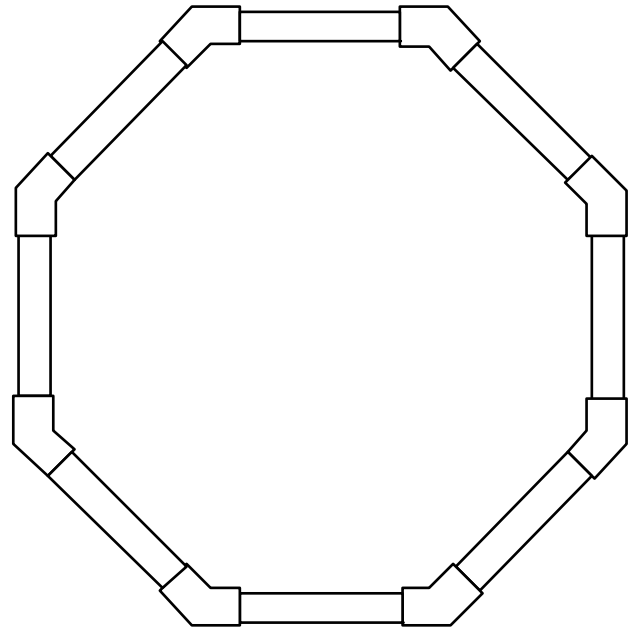

## Assembly Instructions:

1. Use the PVC cutters to cut eight 12" pieces of PVC pipe. Assemble the toy corral to assure proper fit and alignment. Use the pliers as necessary to disconnect one joint at a time, apply PVC cleaner and cement, then reassemble the joint.
2. Continue the cementing procedure until all 16 joints have been cemented.\*\*

\*The 12" length can be increased to make the octagon larger or decreased to make the octagon smaller.

\*\*For ease of storage and transport you may wish to leave two joints uncemented so that the corral can be broken down into two halves.



ATEN  
1207 Mellonville Ave  
Sanford, FL 32771  
[www.aten.scps.k12.fl.us](http://www.aten.scps.k12.fl.us)  
(407)688-2201 or (800)328-3678



# PVC Design: Small Switch Stand

## Parts:

½" PVC pipe:

Two 2" pieces

Two 1¾" pieces

One ½" PVC 90° elbow

Two ½" PVC T joints

Two ½" PVC end caps

Velcro dots (for attaching switch)

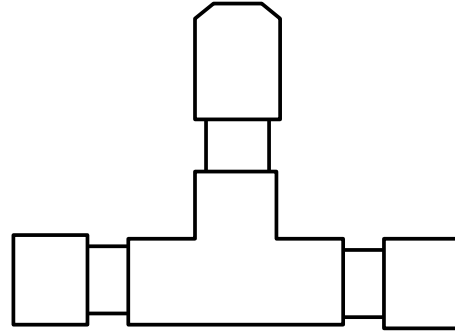

## Tools/Supplies:

Pliers

PVC cement

PVC cleaner

PVC cutters

## Assembly Instructions:

1. Use the PVC cutters to cut two 1¾" pieces and two 2" pieces of PVC pipe.
2. Using the side view first, assemble the parts as shown to confirm fit and proper alignment.
3. Take the joints apart, one at a time, using the pliers as necessary. Apply PVC cleaner and cement, then reassemble the joint before taking apart the next one.
4. Apply Velcro dots in appropriate places to mount your selected switch.

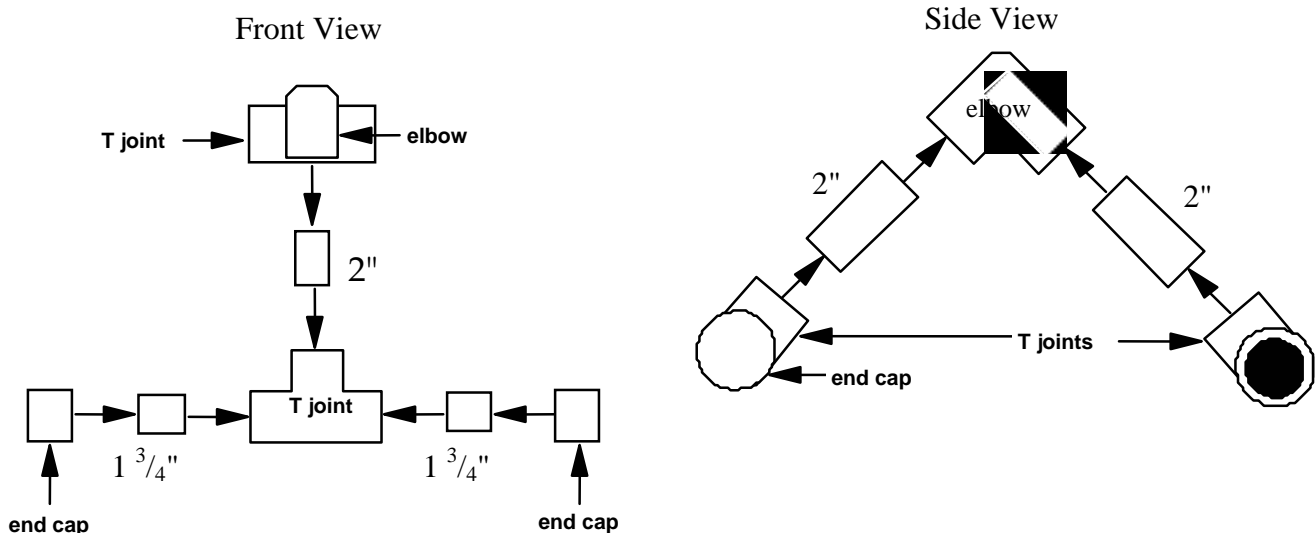

ATEN  
1207 Mellonville Ave  
Sanford, FL 32771  
[www.aten.scps.k12.fl.us](http://www.aten.scps.k12.fl.us)  
(407)688-2201 or (800)328-3678



# PVC Design: Large Switch Stand

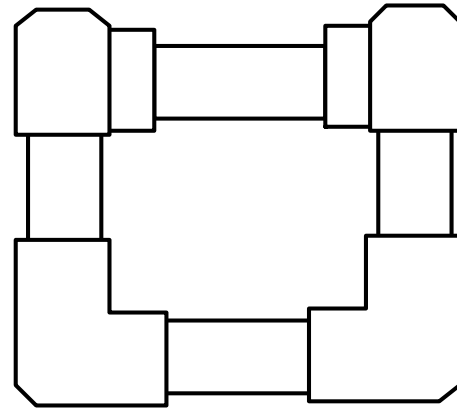

## Parts:

1/2" PVC pipe:

Two 3" pieces

Four 2 1/2" pieces

Six 1/2" PVC 90° elbows

## Tools/Supplies:

Pliers

PVC cutters

PVC cleaner

PVC cement

Velcro Dots (for attaching switch)

## Assembly Instructions:

1. Use the PVC cutters to cut the pipe into the lengths specified in the **Parts** section above.
2. Assemble two pieces identical to the side view below. Connect the two side pieces using the two remaining 3" pieces. Use the pliers as necessary to disconnect one joint at a time, apply PVC cleaner and cement, then reassemble the joint. Continue this procedure until all joints have been secured. Attach Velcro in desired locations.

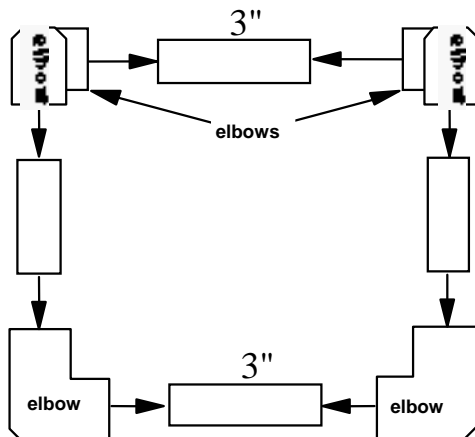

Front View

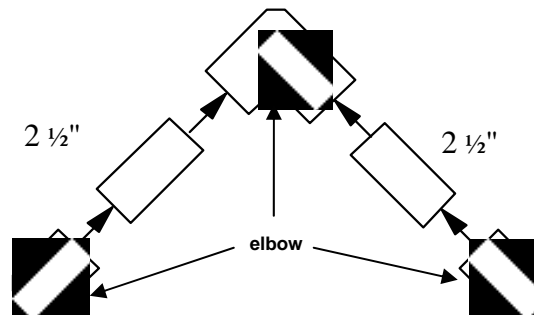

Side View



ATEN  
1207 Mellonville Ave  
Sanford, FL 32771  
[www.aten.scps.k12.fl.us](http://www.aten.scps.k12.fl.us)  
(407)688-2201 or (800)328-3678



# PVC Design:

## DynaVox IIc® Stand

### Parts:

½" PVC pipe:

One 8 ¾" piece

Two 4 ¼" pieces

Two 3 ⅝" pieces

Two 3 ½" pieces

Two 2 ⅛" pieces

Ten 1 ½" pieces

Eight ½" PVC 90° elbows

Six ½" PVC T joints

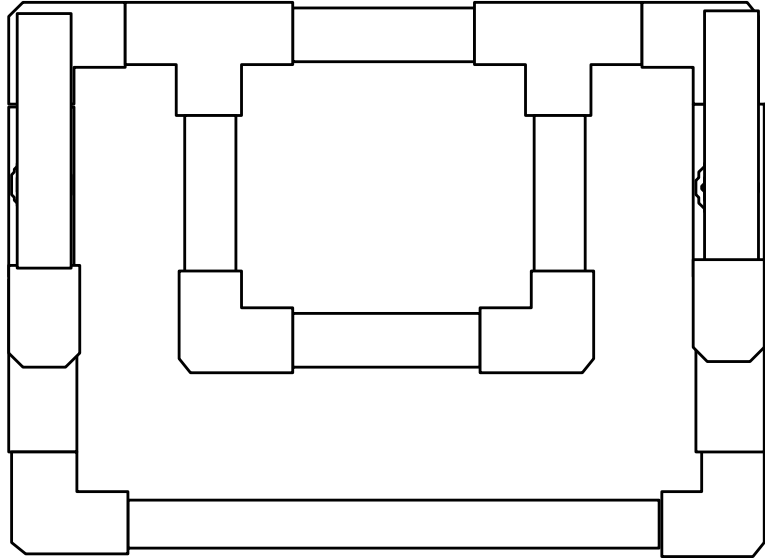

### Tools/Supplies:

Pliers

PVC cement

Paper template

PVC cutters

Grease pencil

### Assembly Instructions:

1. Use the PVC cutters to cut the pipe into the lengths specified in the **Parts** section above.
2. Assemble the stand section as shown on page eighteen. This step requires the following pieces of pipe: two 4 ¼", two 3 ½", and two 1 ½" pieces. The following joint pieces are also need for this step: two T joints and two 90° elbow joints.
3. Assemble 2 of the retainer portions of the frame section as shown on page nineteen. This step requires the following pieces of pipe: two 3 ⅝", two 2 ⅛", and eight 1 ½" lengths. Four T joints and two 90° elbow joints are also required for this step.
4. Next complete the frame section as shown on page twenty. The following items are needed for this step: one 8 ¾" piece of pipe and four 90° elbow joints. Connect the two retainer sections as the sides as shown in the diagram on page twenty.
5. Join the stand section and frame section, but do not cement them together during this step. Use the template on page twenty-one to set the stand to the correct angle. Place the stand on the template so that it aligns with the lines as indicated. Then use the grease pencil to mark the joints where the stand portion and frame portion meet as shown on page twenty.
6. Separate the two sections again, apply cement and assemble them so that the grease pencil lines are aligned.



ATEN  
1207 Mellonville Ave  
Sanford, FL 32771  
[www.aten.scps.k12.fl.us](http://www.aten.scps.k12.fl.us)  
(407)688-2201 or (800)328-3678



**Stand Section**  
(Shown in gray)

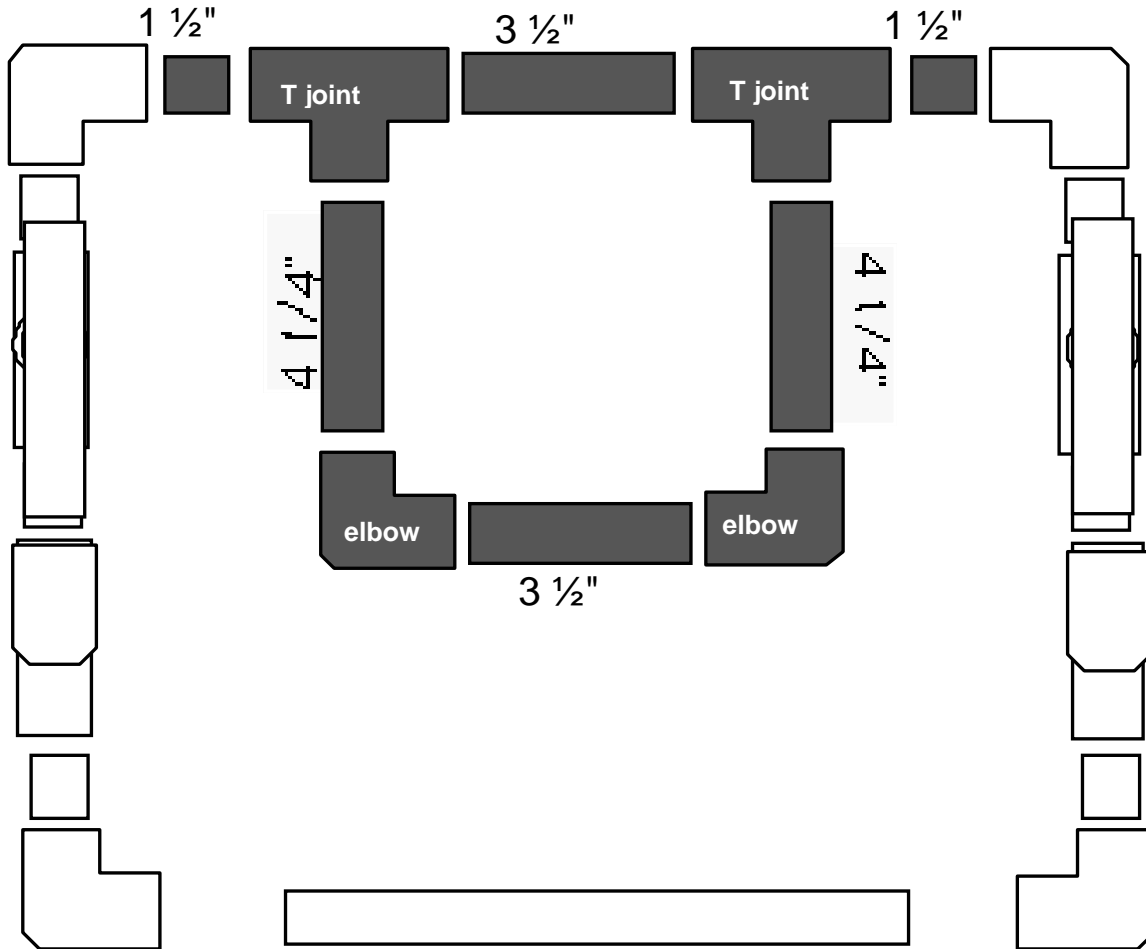

Front View



ATEN  
1207 Mellonville Ave  
Sanford, FL 32771  
[www.aten.scps.k12.fl.us](http://www.aten.scps.k12.fl.us)  
(407)688-2201 or (800)328-3678



### Retainer Sections (shown in gray)

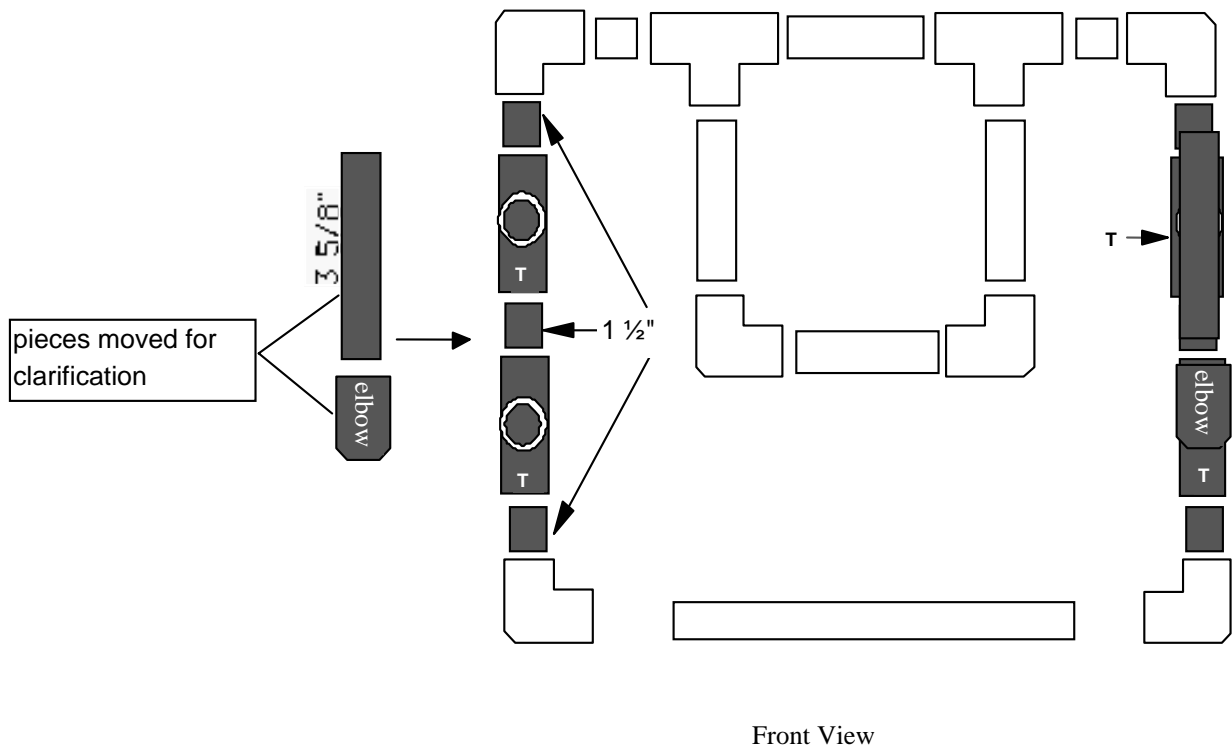
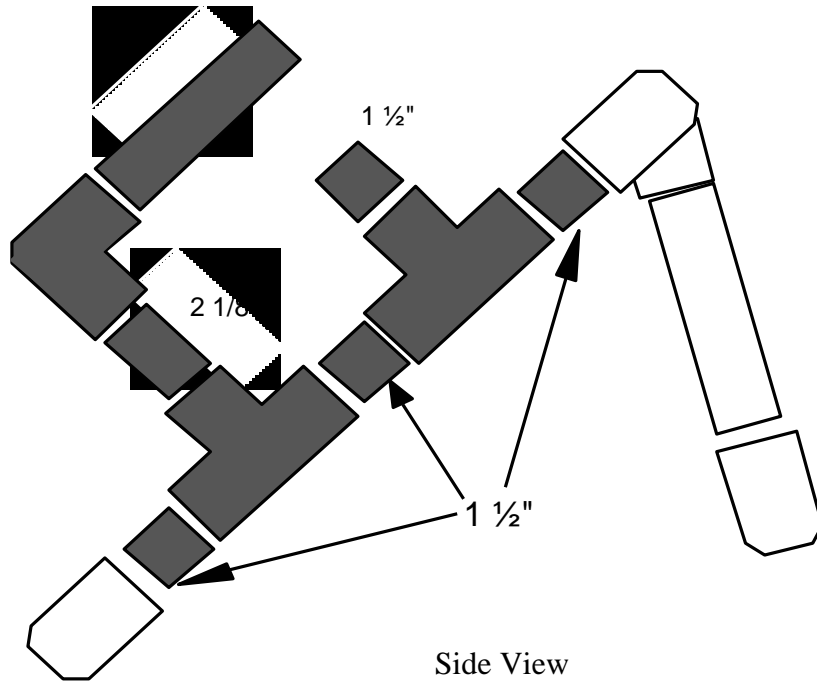

ATEN  
1207 Mellonville Ave  
Sanford, FL 32771  
[www.aten.scps.k12.fl.us](http://www.aten.scps.k12.fl.us)  
(407)688-2201 or (800)328-3678



Lower /Upper Frame Sections  
(shown in gray)

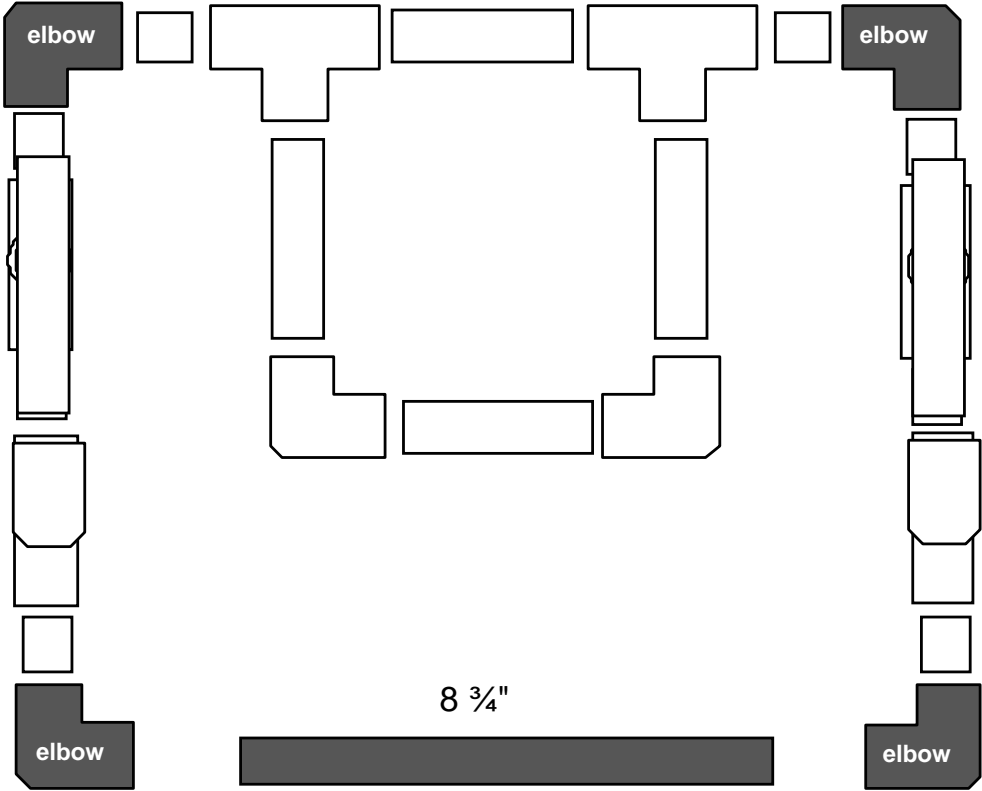

Front View

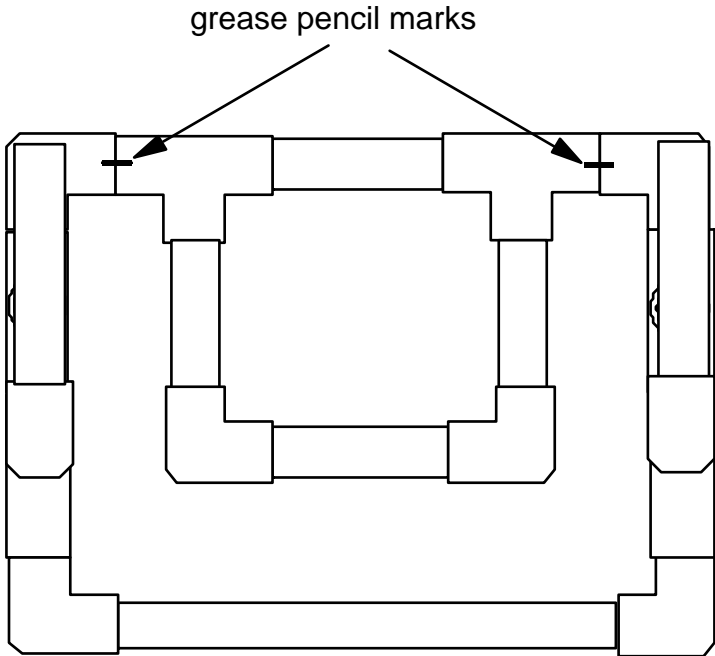

ATEN  
1207 Mellonville Ave  
Sanford, FL 32771  
[www.aten.scps.k12.fl.us](http://www.aten.scps.k12.fl.us)  
(407)688-2201 or (800)328-3678



## DynaVox® Stand Angle Template

Place stand on gray area.

Place stand on gray area.



ATEN  
1207 Mellonville Ave  
Sanford, FL 32771  
[www.aten.scps.k12.fl.us](http://www.aten.scps.k12.fl.us)  
(407)688-2201 or (800)328-3678



# PVC Design: Sensory Stimulation Stand

## Parts:

- ½" PVC pipe:
  - Three 12" pieces
  - Two 9" pieces
  - Four 4" pieces
- Six ½" PVC 90° elbows
- Two ½" PVC T joints
- 9 bead necklaces (cut in half to make 18 strands of beads)

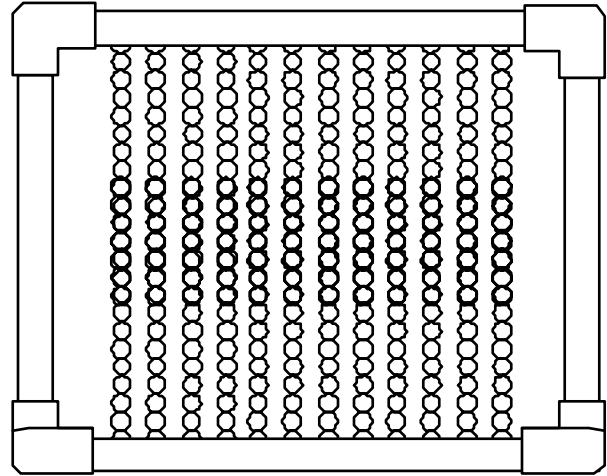

## Tools/Supplies:

- |              |               |
|--------------|---------------|
| Pliers       | PVC cutters   |
| PVC cement   | PVC cleaner   |
| Hot glue gun | Grease pencil |

## Assembly Instructions

1. Before beginning, use the PVC cutters to cut the pipe into the lengths specified in the **Parts** section above.
2. Using two 9" pieces of pipe and two 90° elbow joints, assemble and cement the vertical frame section as shown.

### Vertical Frame

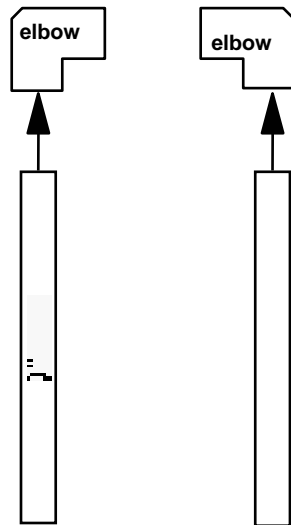

### Vertical Frame Section (shown in gray)

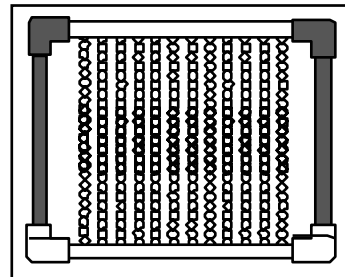

Front View

- Use four 4" pieces of pipe, two 12" pieces of pipe, and four 90° elbows to assemble and cement the base sections. Use the table surface to position each joint as you cement it.

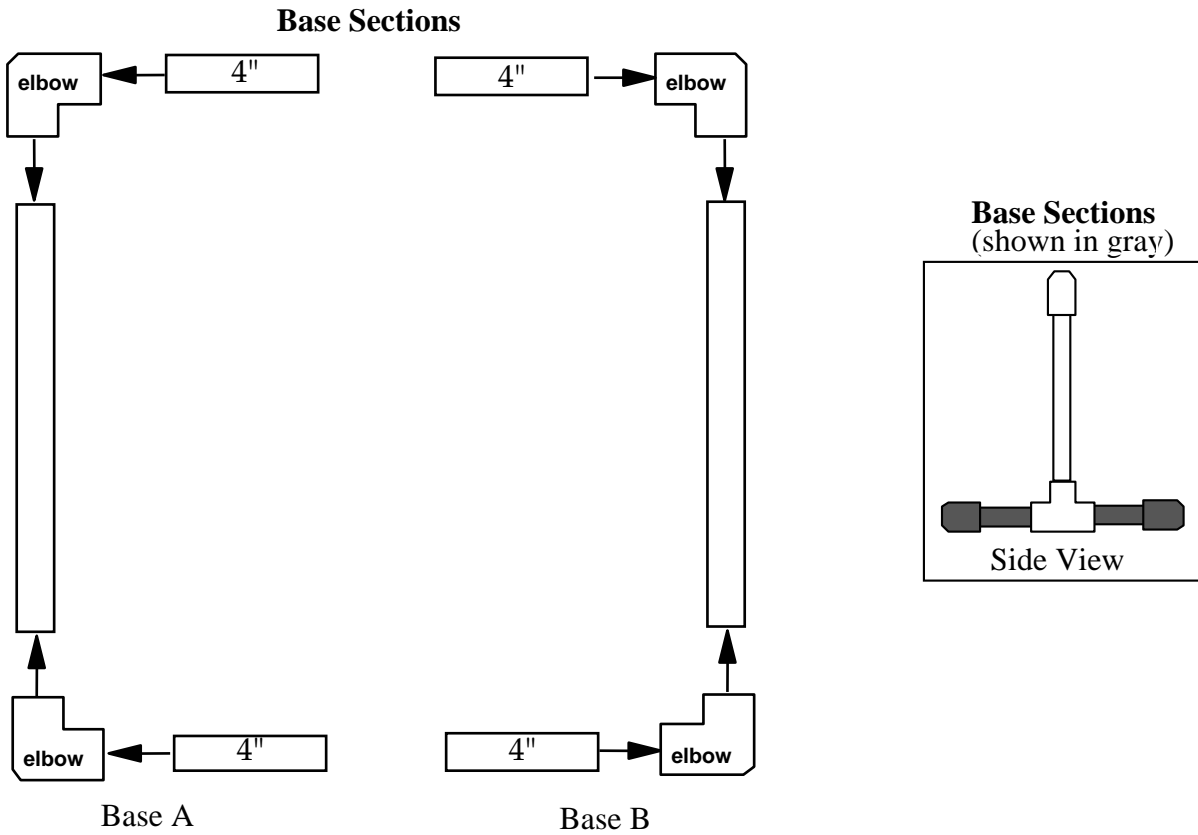

- Use a 12" piece of pipe to assemble the bead bar section. Insert, do not cement, the 12" pipe (used to hold the beads) between the two vertical frame components. Connect Base A and the vertical frame to the two T joints as shown. Align all joints and mark with a grease pencil on the T joints and adjoining pieces.

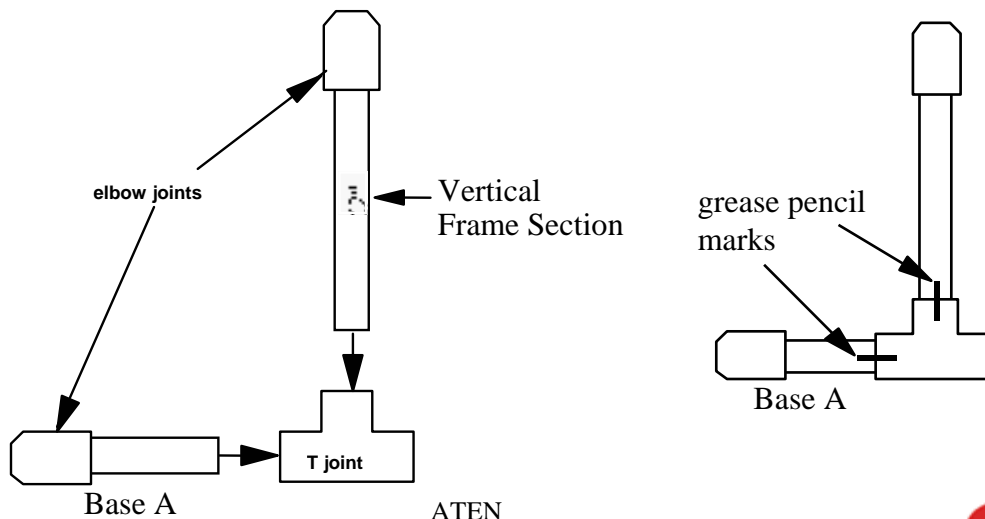

ATEEN  
1207 Mellonville Ave  
Sanford, FL 32771  
[www.aten.scps.k12.fl.us](http://www.aten.scps.k12.fl.us)  
(407)688-2201 or (800)328-3678



5. Remove the vertical frame and Base A from the T joints. Apply PVC cleaner and cement to one joint at a time, then join them together so that the grease pencil markings are aligned. Cement Base B to the T joints.

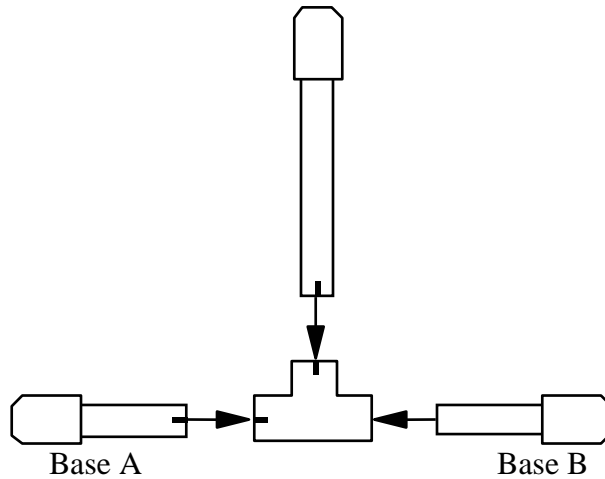

**Bead Bar Assembly Instructions:**

6. Construct the bead bar assembly as follows:
  - 6.1. Holding a 12” piece of PVC pipe against the edge of the table, mark a line along the length to the piece with a grease pencil.
  - 6.2. Use the PVC cutters to cut along the line, splitting the pipe down its length.
  - 6.3. Slide the beads into the slit in the pipe, spacing them evenly.
  - 6.4. Use the hot glue gun to glue around the beads along the slit cut into the pipe for extra stability. Let the hot glue set before adding the bead bar to the rest of the product.
7. When finished with the Bead Bar assembly, cement it to the two vertical frame pieces as shown.

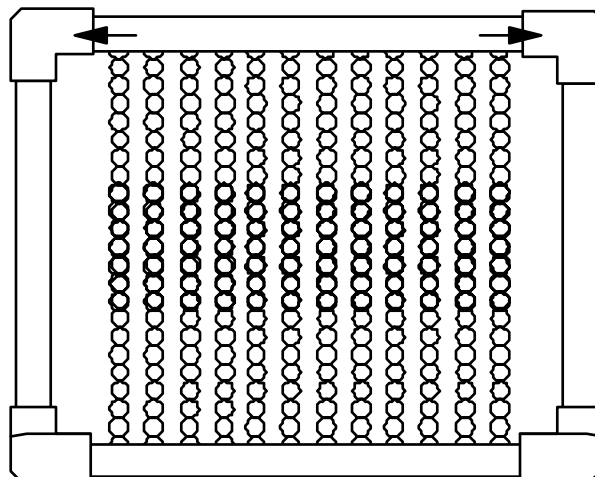

ATEN  
1207 Mellonville Ave  
Sanford, FL 32771  
[www.aten.scps.k12.fl.us](http://www.aten.scps.k12.fl.us)  
(407)688-2201 or (800)328-3678



# PVC Design: Felt Story Board Easel

## Parts:

- ½" PVC pipe:
  - One 13" piece
  - Two 10 ¾" pieces
  - Two 8" pieces
  - One 5" piece
  - Two 2 ½" pieces
- Four ½" PVC 90° elbows
- Two ½" PVC T joints
- Two ½" PVC end caps
- Velcro (for attachment of felt board)

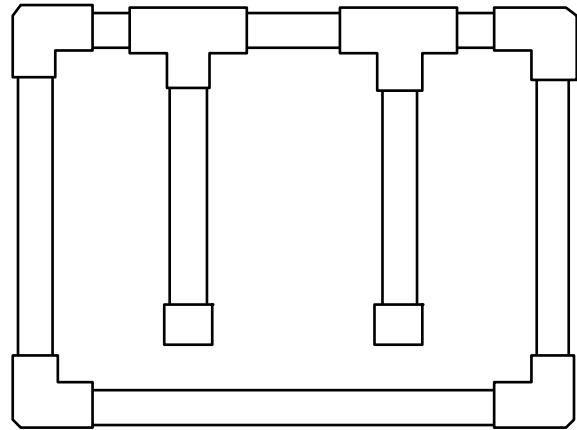

## Tools/Supplies:

- |               |             |
|---------------|-------------|
| Pliers        | PVC cutters |
| PVC cement    | PVC cleaner |
| Grease pencil | Velcro      |

## Assembly Instructions:

1. Use the PVC cutters to cut the pipe into the lengths specified in the **Parts** section above.
2. Assemble and cement the frame section as shown on page twenty-six. This step will require the following pieces of pipe: two 10 ¾" and one 13" length. You will also need four 90° elbow joints.
3. Assemble and cement the stand section as shown on page twenty-seven. This step will require the following pieces of pipe: two 8", one 5", and two 2 ½" lengths. Two T joints and two end caps are also necessary to complete the stand section.
4. Join the frame and stand sections together as shown on page twenty-seven. Do not cement them together yet. Adjust the easel to the desired angle and use the grease pencil to mark across the two joints where the elbow joints of the frame section join the stand section. Then separate the two sections again.
5. Apply cleaner and cement to the two joints and assemble. Be sure to align the grease pencil marks.
6. Apply Velcro as necessary to attach the felt story board.



ATEN  
1207 Mellonville Ave  
Sanford, FL 32771  
[www.aten.scps.k12.fl.us](http://www.aten.scps.k12.fl.us)  
(407)688-2201 or (800)328-3678



**Frame Section**

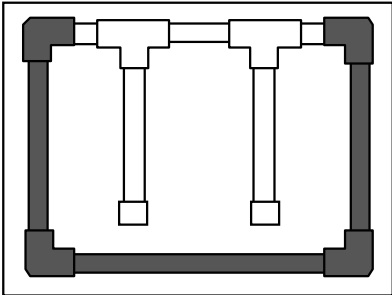

Front View

**Frame Section**

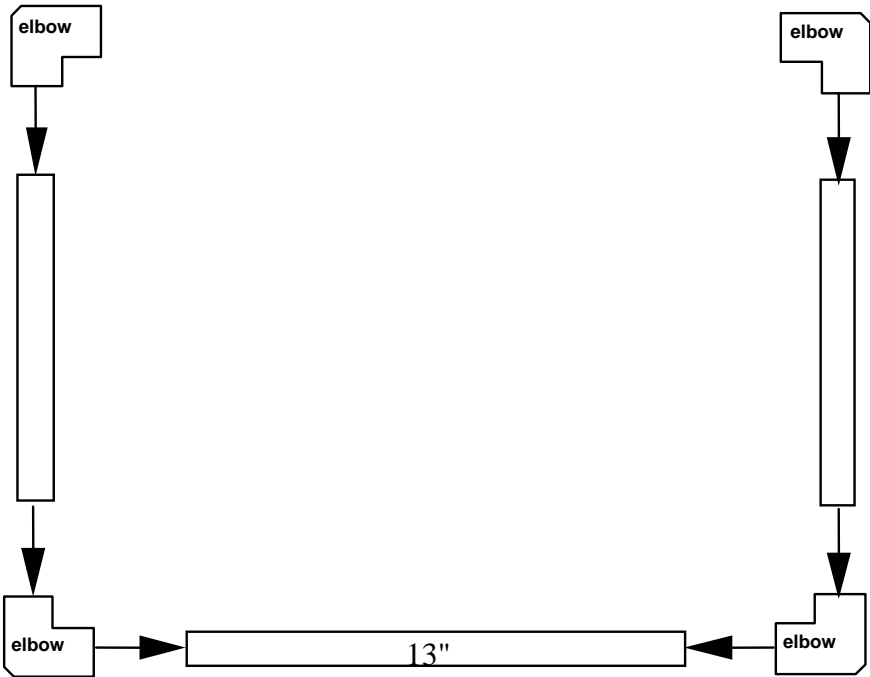

ATEN  
1207 Mellonville Ave  
Sanford, FL 32771  
[www.aten.scps.k12.fl.us](http://www.aten.scps.k12.fl.us)  
(407)688-2201 or (800)328-3678



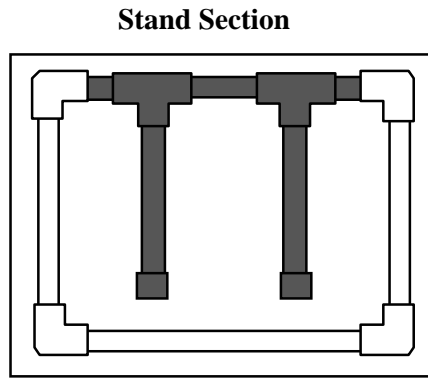
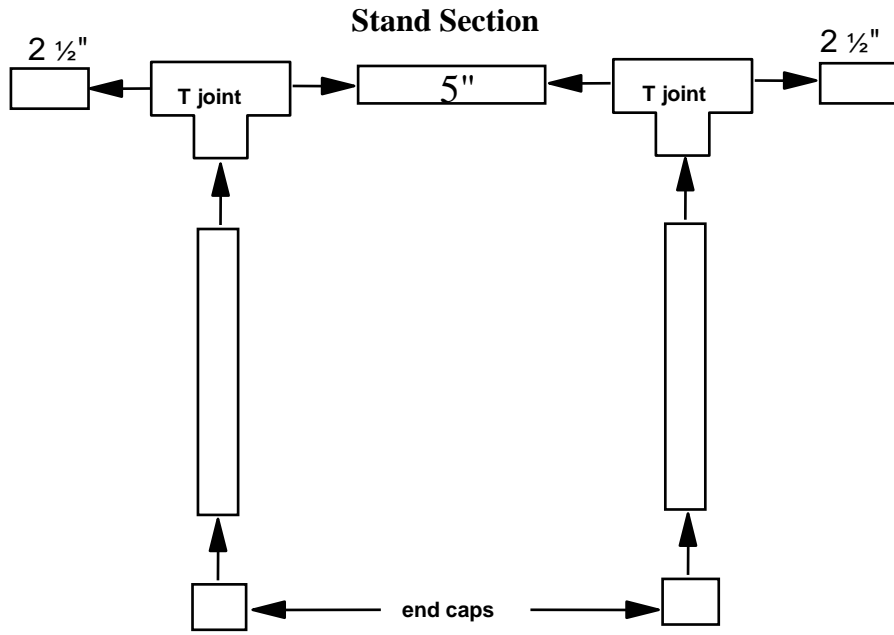

Front View

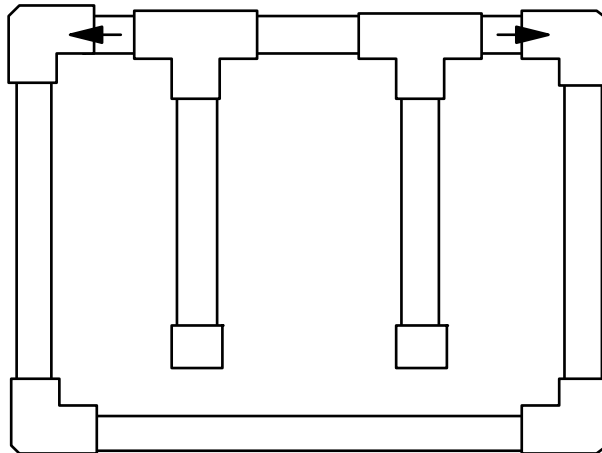

ATEN  
1207 Mellonville Ave  
Sanford, FL 32771  
[www.aten.scps.k12.fl.us](http://www.aten.scps.k12.fl.us)  
(407)688-2201 or (800)328-3678



## PVC Design: Dual-Angle Easel

### Parts:

½" PVC pipe:

One 11" piece

Two 10 ½" pieces

One 7 ½" piece

Two 3 ¼" pieces

Two 3" pieces

Four ½" PVC 90° elbows

Two ½" PVC T joints

Two ½" PVC end caps

### Tools/Supplies:

Pliers

PVC cutters

PVC cement

PVC cleaner

Grease pencil

Angle template

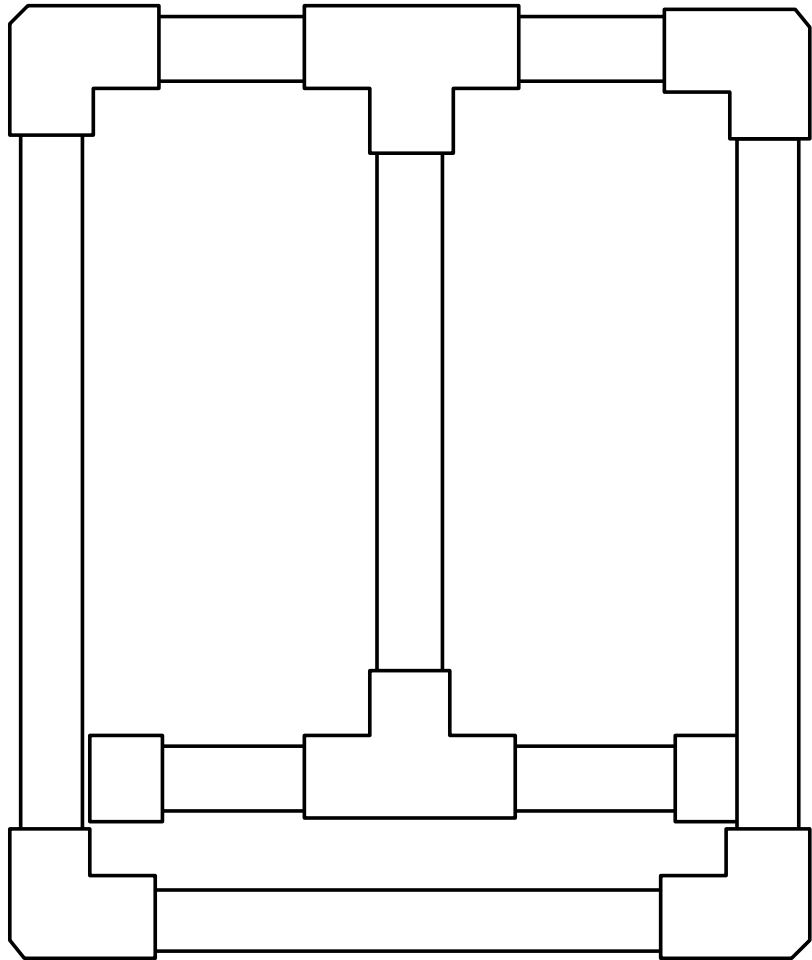

### Assembly Instructions:

1. Use the PVC cutters to cut the pipe into the lengths specified in the **Parts** section on this page.
2. Assemble and cement the frame section as shown on page twenty-nine. This step requires the following pieces of pipe: two 10 ½" and one 7 ½" length. Four 90° elbow joints are also necessary for this step.



ATEN  
1207 Mellonville Ave  
Sanford, FL 32771  
[www.aten.scps.k12.fl.us](http://www.aten.scps.k12.fl.us)  
(407)688-2201 or (800)328-3678



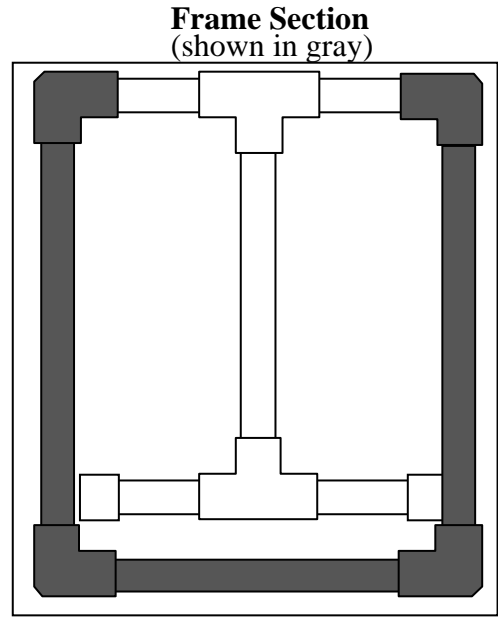
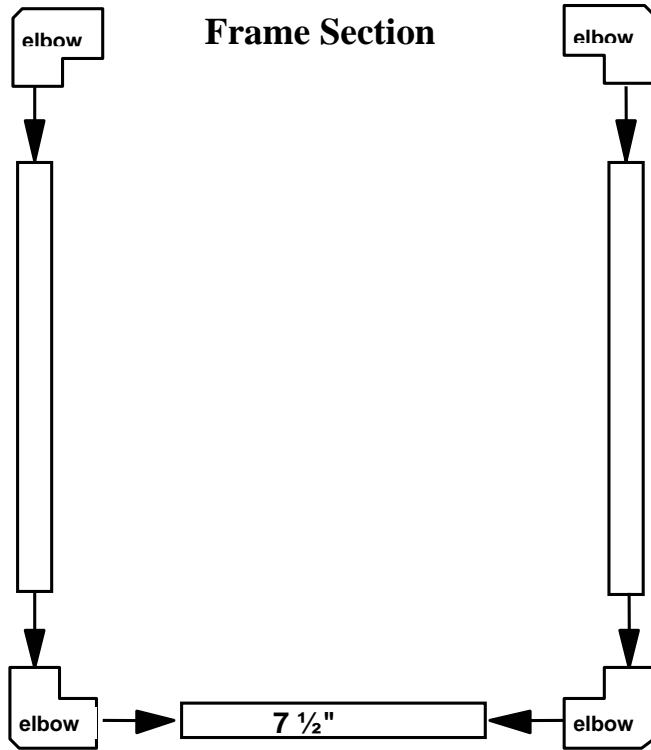

Front View

3. Assemble and cement the stand arm section next. For this step, use the following pieces of pipe: one 11", two 3 1/4", and two 3" lengths. Two end caps and two T joints will also be used in this step.

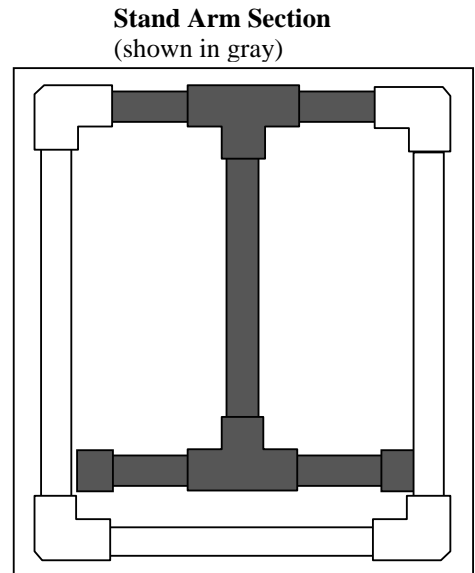
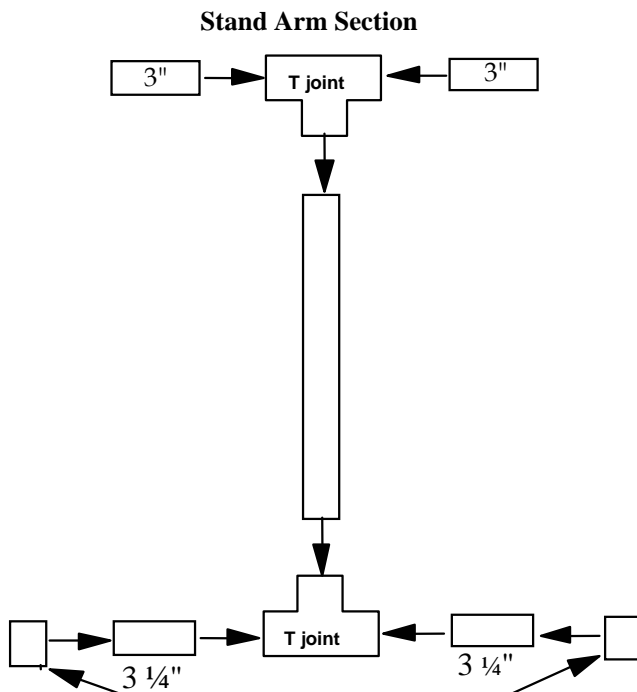

Front View



ATEN  
1207 Mellonville Ave  
Sanford, FL 32771  
[www.aten.scps.k12.fl.us](http://www.aten.scps.k12.fl.us)  
(407)688-2201 or (800)328-3678



4. Connect the stand arm pieces to the frame 90° elbows as shown. Do not cement these pieces into the elbows at this point.

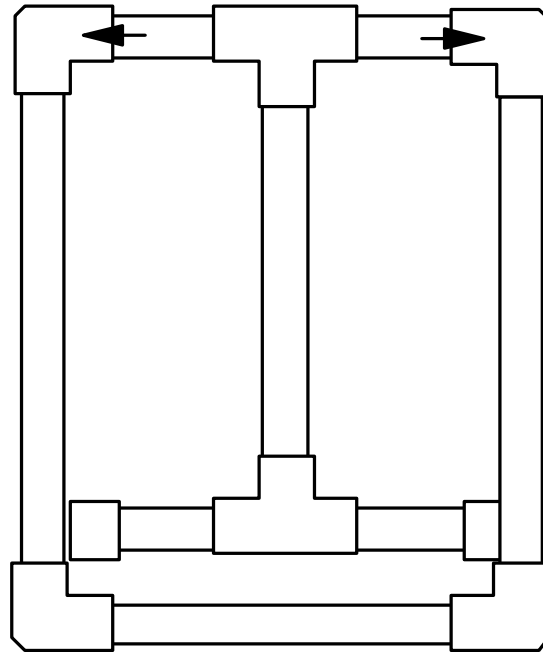

5. Bend the stand arm so that the bottom edge of the easel and the arm are aligned with the paper template's markings as shown. Mark lines with the grease pencil across the top of the easel as shown.

6. Remove the stand from the frame, apply cement to both sides, cement the stand arm into both sides of the frame. Make sure you align the pencil marks.

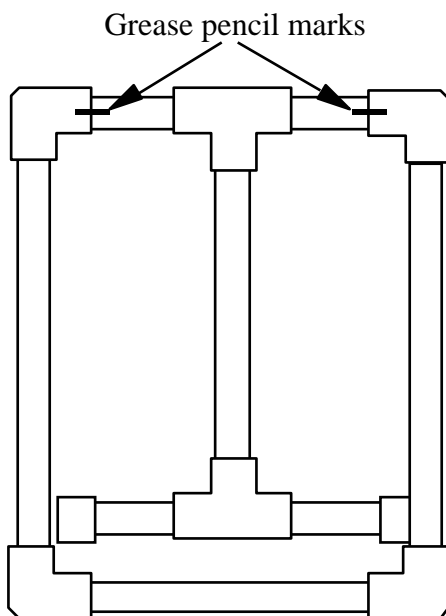

Front View

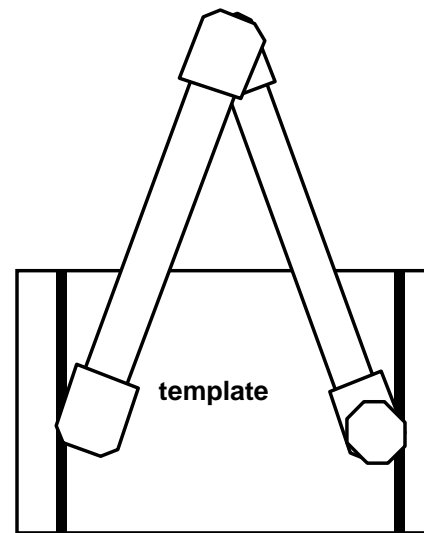

Side View



ATEN  
1207 Mellonville Ave  
Sanford, FL 32771  
[www.aten.scps.k12.fl.us](http://www.aten.scps.k12.fl.us)  
(407)688-2201 or (800)328-3678



# Dual-Angle Easel Template

Place easel on gray area.

Place easel on gray area.



ATEN  
1207 Mellonville Ave  
Sanford, FL 32771  
[www.aten.scps.k12.fl.us](http://www.aten.scps.k12.fl.us)  
(407)688-2201 or (800)328-3678



# PVC Design: Adjustable-Height Switch Mount

## Parts:

- ½" PVC pipe:
  - One 13" piece
  - Two 7" pieces
  - One 4" piece
  - Two 1 ½" pieces
- Two ½" PVC male threaded adapters
- Two ½" PVC 90° elbows
- Three ½" PVC T joints
- Two ground clamps
- Four 2 ¼"x ¼" machine screws
- Four ¼" nuts
- One ½" metal floor flange
- One ½" pipe clamp

## Tools/Supplies:

- |                      |                  |
|----------------------|------------------|
| Pliers               | PVC cutters      |
| Screw driver         | PVC cement       |
| PVC cleaner          | Grease pencil    |
| Drill press or drill | 17/64" drill bit |

## Note:

**This mount is for table attachment only.  
Do not attach to wheelchair frames or other  
positioning equipment.**

## **Assembly Instructions:**

1. Use the PVC cutters to cut the pipe into the lengths specified in the **Parts** section above.
2. Assemble and cement the arm section as shown. This will require the following pieces of pipe: one 7" and one 13" length. This step also requires one male adapter and one 90° elbow.

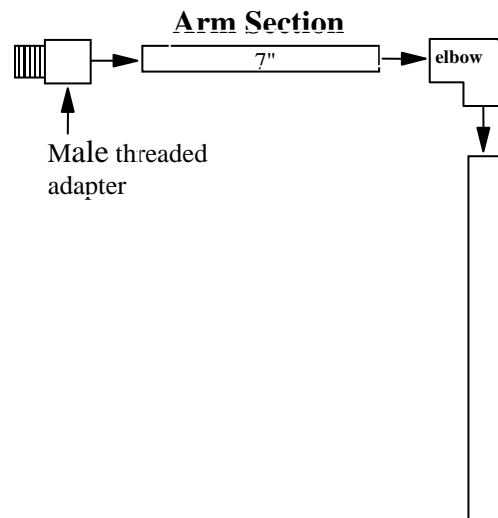
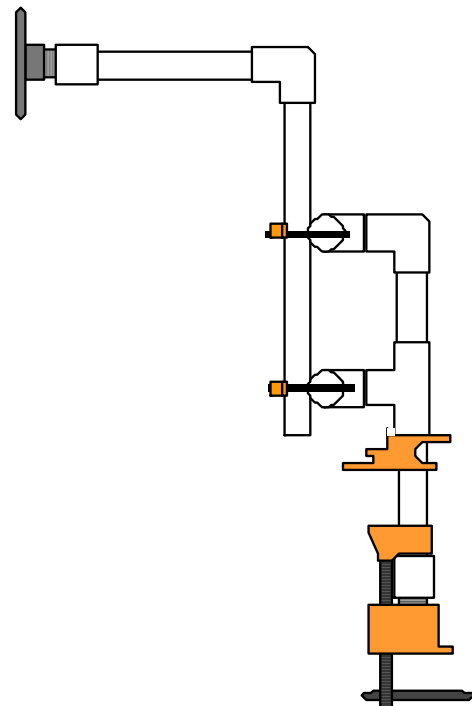

ATEN  
1207 Mellonville Ave  
Sanford, FL 32771  
[www.aten.scps.k12.fl.us](http://www.aten.scps.k12.fl.us)  
(407)688-2201 or (800)328-3678



3. Assemble and cement the upright portion of the clamp section as shown. This requires the following pieces of pipe: one 4", two 1 1/2", and one 7" length. One 90° elbow, one T joint, one male threaded adapter, and one 1/2" pipe clamp are also required for this step. Use a flat surface to align the T joint and 90° elbow. Prior to cementing the male adapter to the base, place the pipe clamp components on the PVC piece as shown and screw the male threaded adapter into the pipe clamp.
4. Use a drill press to drill two 17/64" holes in two T joints as shown below. If a drill press is not available, a drill may be used (holes may need to be larger due to decreased accuracy with this method). Use the grease pencil to mark the location for the holes by placing the ground clamp over the T joint and marking inside the holes.
5. Attach the two drilled T joints to the mount base as shown. Use the grease pencil to mark alignment, and cement the T joints to the mount base.

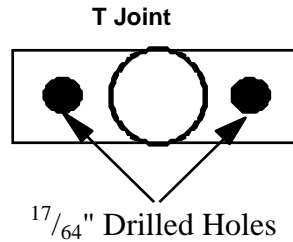
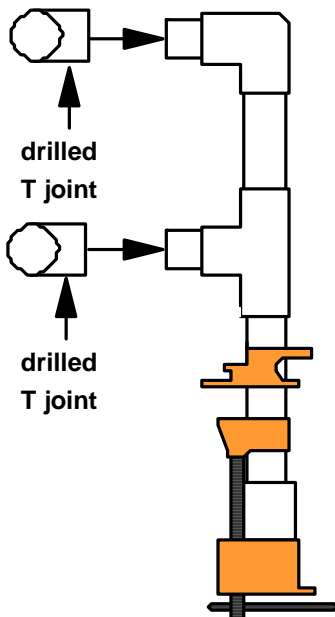
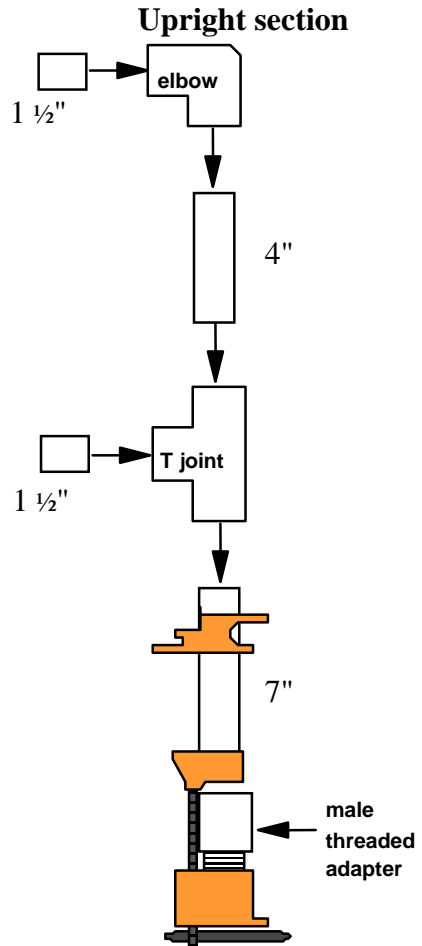

6. Attach the metal floor flange to the male adapter on the adjustable arm as shown. Using the screws and nuts, attach the ground clamps to the two drilled T joints on the mount upright section.
7. Insert the adjustable arm into the gap between the ground clamps and T joints. Tighten the nuts until the arm does not move. Test the mount by attaching it to a table surface.
8. Switches may be attached to the floor flange using Velcro or a wood block and screws.

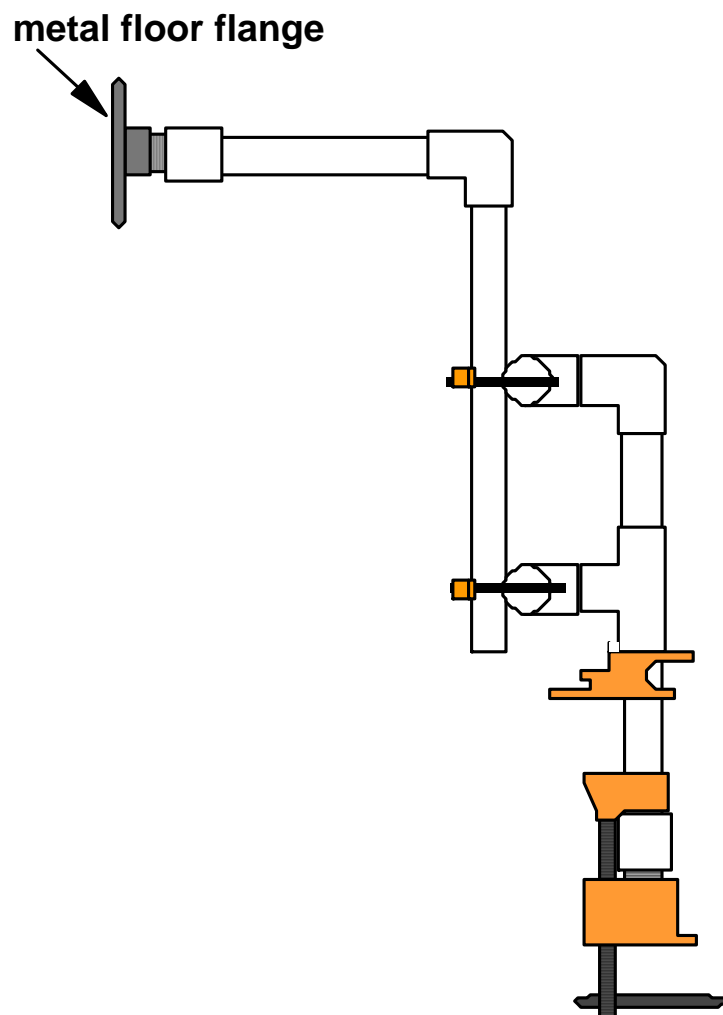

# PVC Design: Toy Bowling Ball Launcher

## Parts:

½" PVC pipe:

Two 24 ½" pieces

One 23 ½" piece

Two 21 ½" pieces

One 11 ½" piece

Two 9 ⅛" pieces

One 8" piece

Four 5 ½" pieces

Three 3 ¼" pieces

Two 2" pieces

Eleven 1 ½" pieces

Eleven ½" PVC 90° elbows

Eleven ½" PVC T joints

One ½" PVC end cap

One ½" PVC 45° elbow

## Tools/Supplies

Pliers

PVC cutters

PVC cement

PVC cleaner

Metal file

Grease Pencil

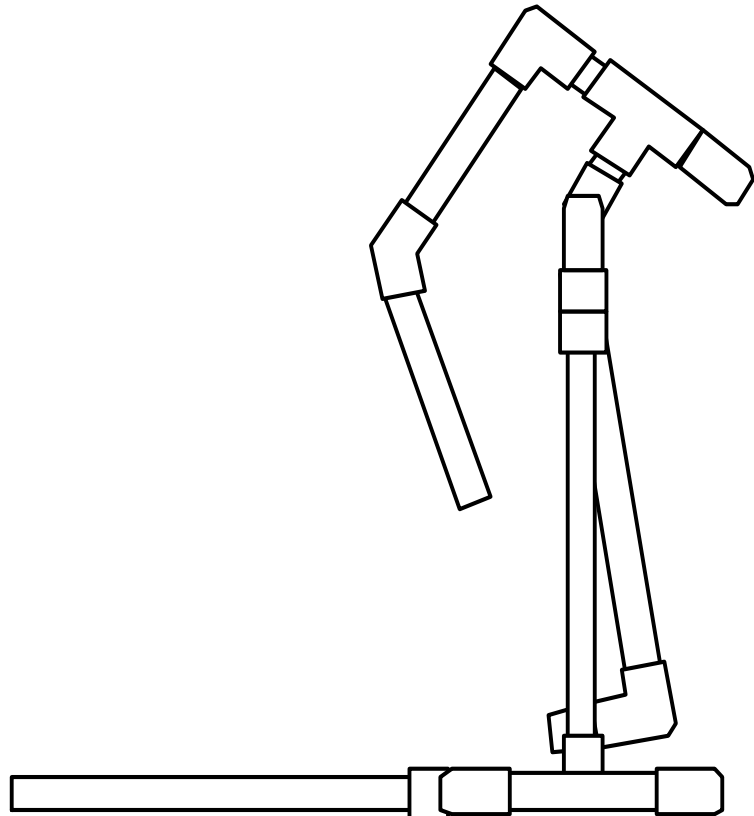

## Assembly Instructions:

1. Use the PVC cutters to cut the pipe into the lengths specified in the **Parts** section on page one.
2. Assemble and cement the release arm as shown on page thirty-six. This will require the following pieces of pipe: one 11 ½", one 8", two 2", and one 1 ½" length. You will also need two 90° elbows, one T joint, and one 45° elbow. It is important to take note of the one joint that does not get cemented and the end of the 2" piece of pipe that requires filing.
3. Next assemble and cement the base/ramp as shown on page thirty-seven. This will require the following pieces of pipe: two 21 ½", two 9 ⅛", four 5 ½", three 3 ¼", and four 1 ½" lengths. You will also need six elbows and six T joints. Assemble and cement the base/ramp's two mirror imaged halves separately, joining them with the 3 ¼" piece of pipe after assembly.
4. Build the upright frame next as shown on page thirty-eight. This step requires the following pieces of pipe: two 24 ½" and four 1 ½" lengths. This step will also require three T joints and



ATEN  
1207 Mellonville Ave  
Sanford, FL 32771  
[www.aten.scps.k12.fl.us](http://www.aten.scps.k12.fl.us)  
(407)688-2201 or (800)328-3678



two elbows. Do not cement the T joint at the top of the upright frame during this step. The angle of the T joint needs to be adjusted to accommodate the pendulum arm. Do not attach the upright frame to the base/ramp until the next step has been completed.

5. The last step is to assemble and cement the pendulum arm as shown on page thirty-nine. This step requires the following pieces of pipe: one 23 1/2" and three 1 1/2" lengths. This step also requires one T joint, one elbow, and one end cap. File the ends of the pipes indicated in the diagram. Place the filed pipe ends into the two open T joints on the upright frame. Do not cement these joints.
6. Cement the upright frame into the two vertical T joints of the base/ramp.
7. Attach the release arm to the upright frame by placing the filed pipe end of the release arm into the T joint at the top of the upright frame.
8. Lift the pendulum arm to the rear of the bowling ball launcher and lock it into place using the release arm. Adjust the angle of the T joint at the top of the upright frame so that the release arm is in its most effective position. Use the grease pencil to mark a line from the T joint to each of the adjoining elbow joints. Remove the release arm. Disassemble the top of the upright frame, cement the T joint in place, and reassemble the upright frame, using the grease pencil marks to align the T joint to the proper angle. Make sure the pendulum is in place before cementing is completed.
9. Insert the release arm into the T joint at the top of the upright frame again to complete the assembly.

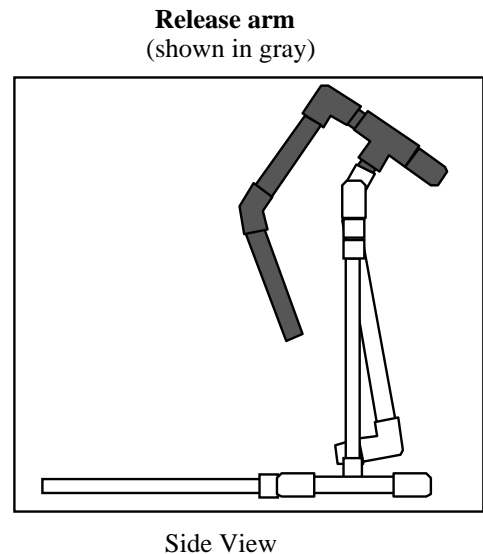
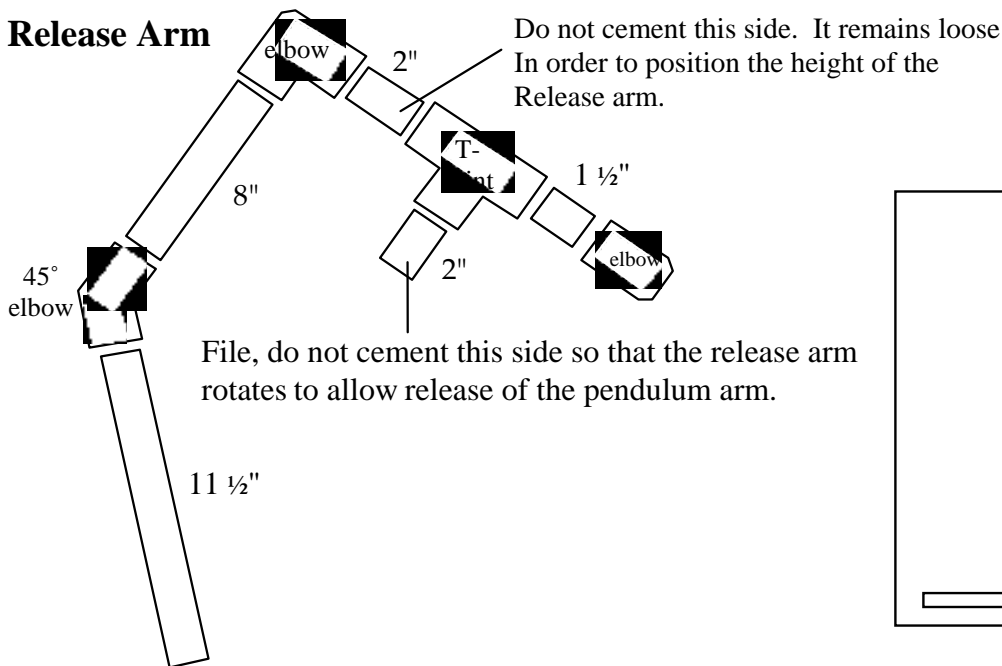

ATEN  
1207 Mellonville Ave  
Sanford, FL 32771  
[www.aten.scps.k12.fl.us](http://www.aten.scps.k12.fl.us)  
(407)688-2201 or (800)328-3678



Assembly Diagrams:

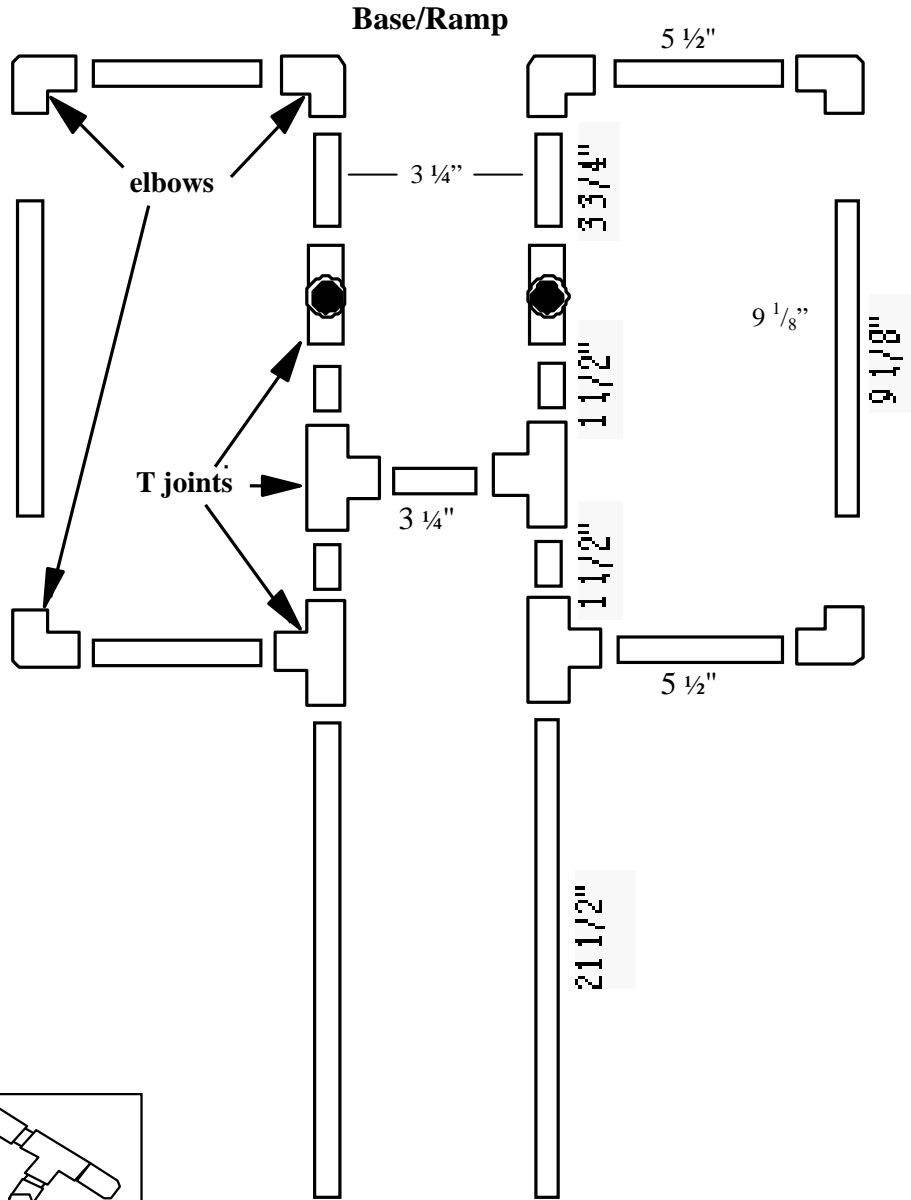

**Base/Ramp**  
(shown in gray)

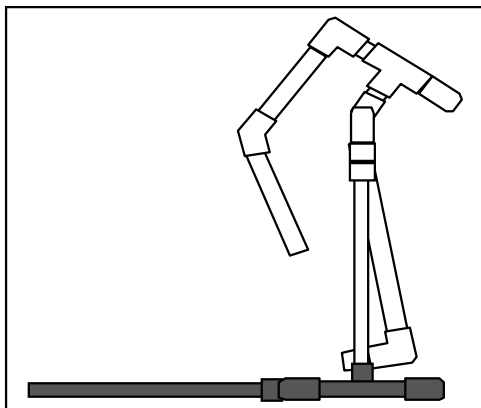

Side View

**Base/Ramp**

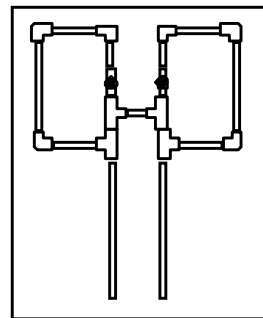

Overhead View



ATEN  
1207 Mellonville Ave  
Sanford, FL 32771  
[www.aten.scps.k12.fl.us](http://www.aten.scps.k12.fl.us)  
(407)688-2201 or (800)328-3678



# Upright frame

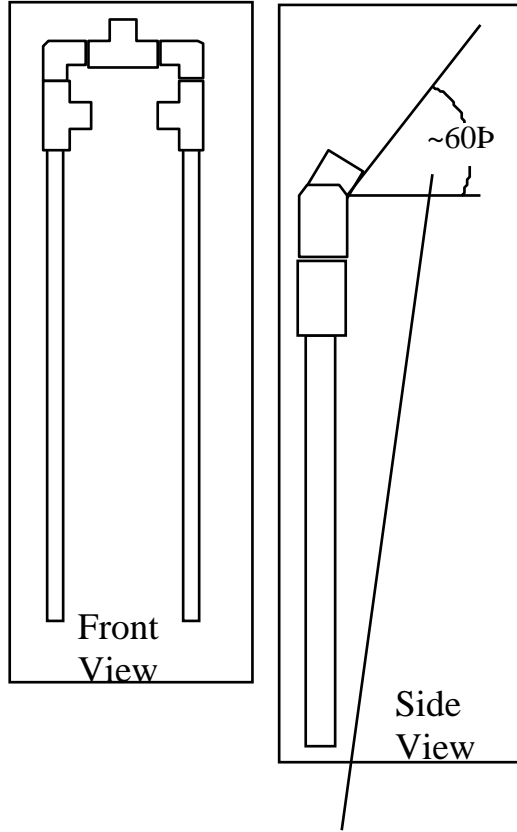
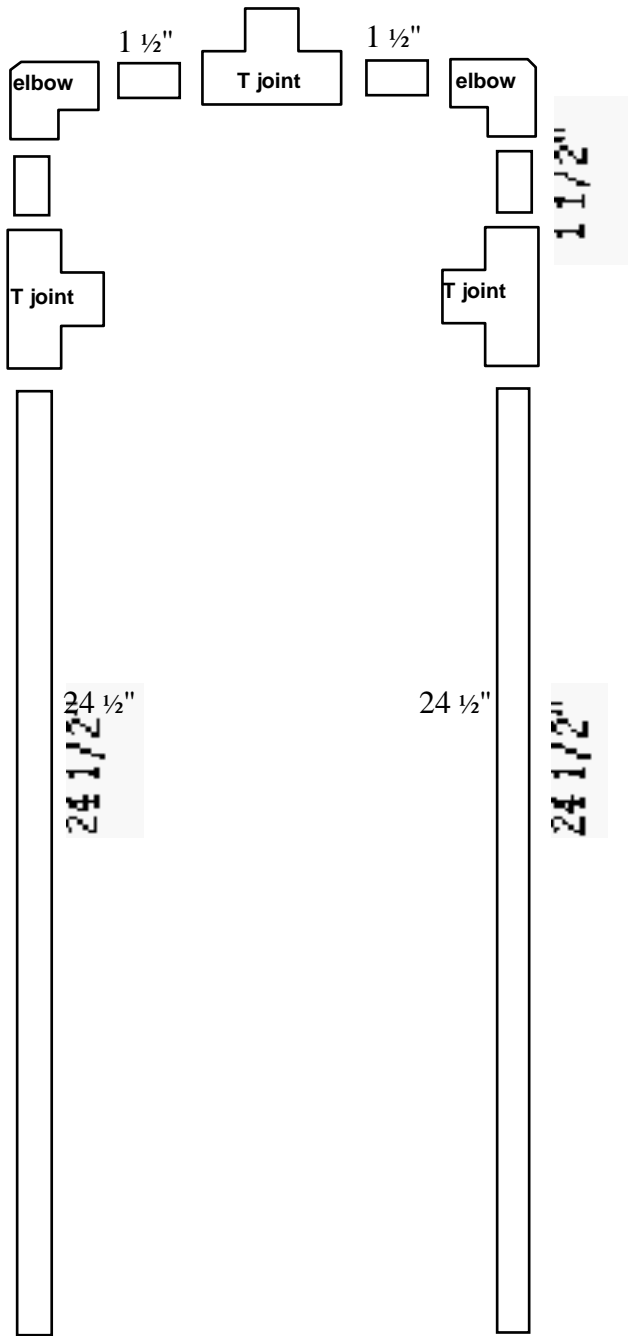

This angle measurement is approximate. Assemble the frame (prior to cementing) and adjust the angle to the highest point at which the release arm can grab the pendulum. Mark this angle and cement the pieces together.

### Upright Frame (shown in gray)

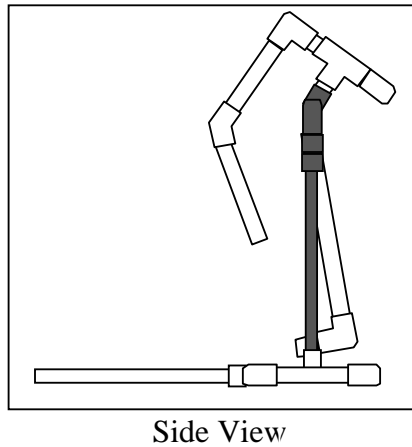

Side View



ATEN  
 1207 Mellonville Ave  
 Sanford, FL 32771  
[www.aten.scps.k12.fl.us](http://www.aten.scps.k12.fl.us)  
 (407)688-2201 or (800)328-3678



# Pendulum Arm

File these ends so that the pendulum arm can rotate freely in the upright frame. Do not cement to the upright frame. Place the pendulum arm in the frame prior to cementing the frame to the base.

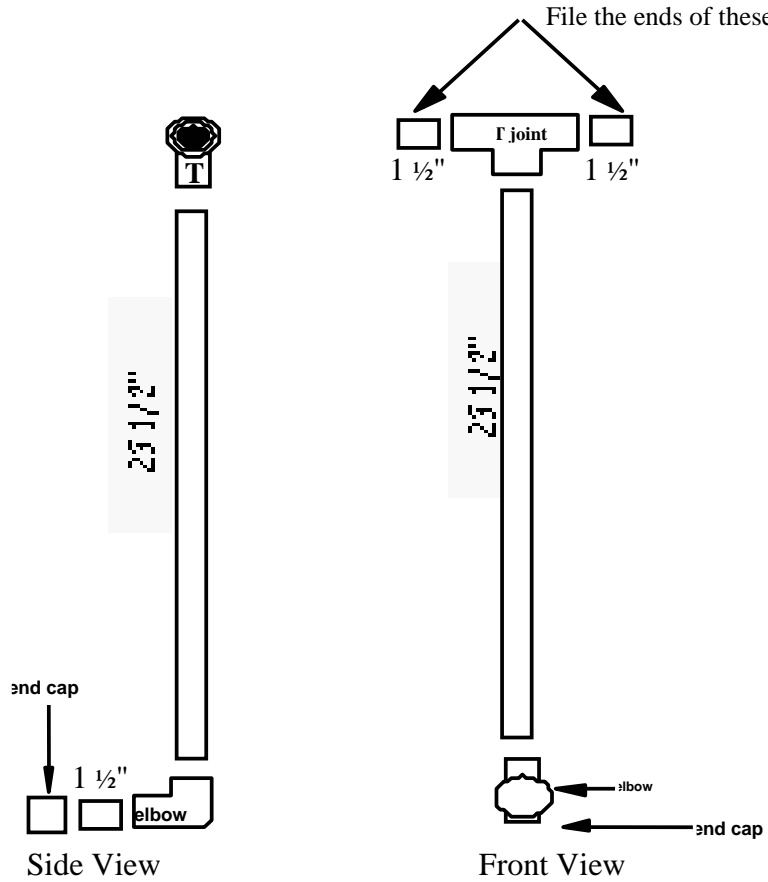

## Pendulum Arm (shown in gray)

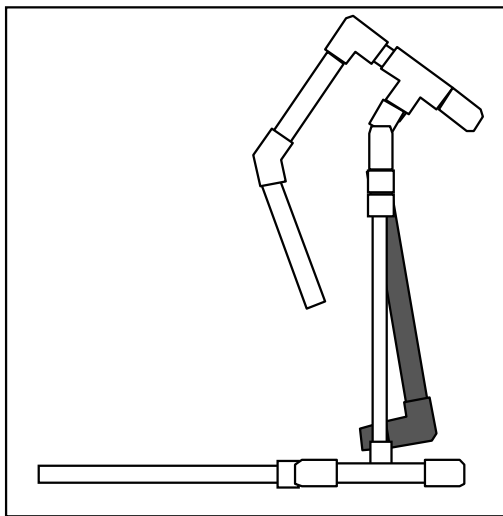

Side View



ATEN  
1207 Mellonville Ave  
Sanford, FL 32771  
[www.aten.scps.k12.fl.us](http://www.aten.scps.k12.fl.us)  
(407)688-2201 or (800)328-3678



# PVC Design: Number Line

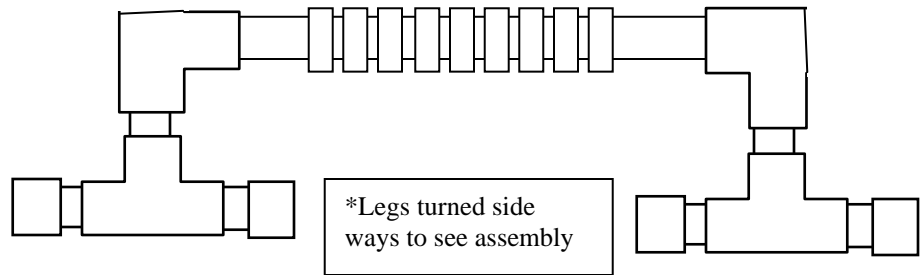

## Parts:

1/2" PVC pipe:

One 18" piece

Six 1 1/2" pieces

Two 1/2" PVC T joints

Two 1/2" PVC elbows

Four 1/2" PVC end caps

1" PVC pipe:

Twenty 5/8" pieces

## Tools/Supplies

Pliers

PVC cutters

PVC cement

PVC cleaner

Tape measure

Sharpie permanent pen

## Assembly Instructions:

1. Use the PVC cutters to cut the **Parts** listed above.
2. Slide the 20 pieces of 1" diameter pipe onto the 18" piece of 1/2" pipe and place a 90° elbow on each end.
3. Assemble the two legs as shown in picture below.
4. Attach the two legs to the long center piece.
5. Use the Sharpie pen to write the numbers in order from 1 to 20 from left to right on each of the 5/8" pieces of PVC pipe.

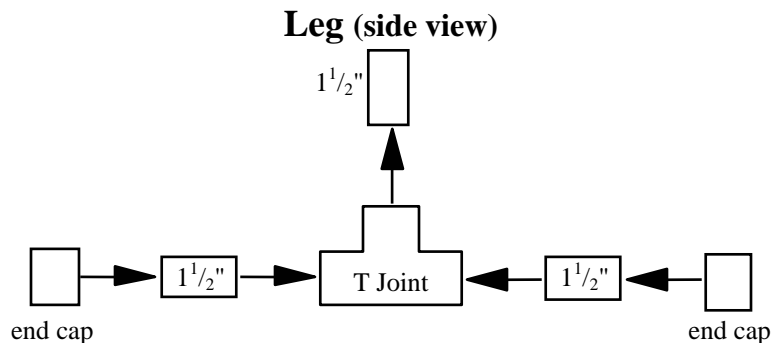

ATEN  
1207 Mellonville Ave  
Sanford, FL 32771  
[www.aten.scps.k12.fl.us](http://www.aten.scps.k12.fl.us)  
(407)688-2201 or (800)328-3678



# PVC Design: Communication Stand

## Parts:

1/2" PVC pipe:

One 17 1/2" piece

Two 8 1/2" pieces

Four 4 1/2" pieces

Two 1/2" PVC T joints

Two 1/2" PVC elbows

Four 1/2" PVC end caps

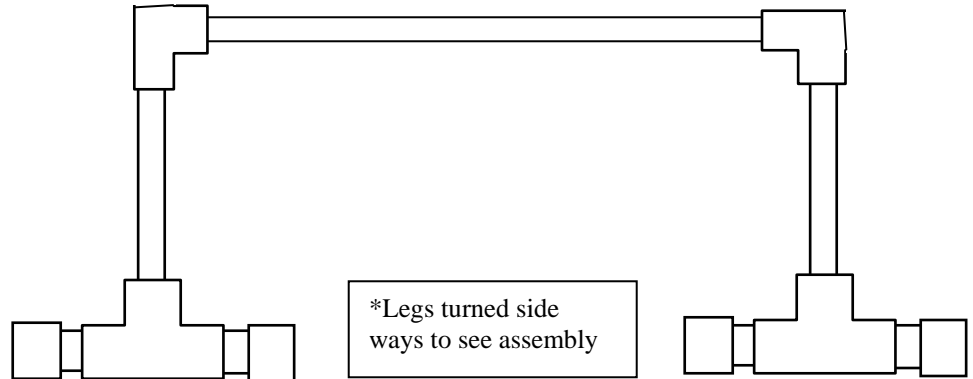

## Tools/Supplies

Pliers

PVC Cement

Tape Measure

PVC Cutters

PVC Cleaner

Grease Pencil

## Assembly Instructions:

1. Use the PVC cutters to cut the **Parts** listed above.
2. Assemble as shown below.

Assemble as Shown Below

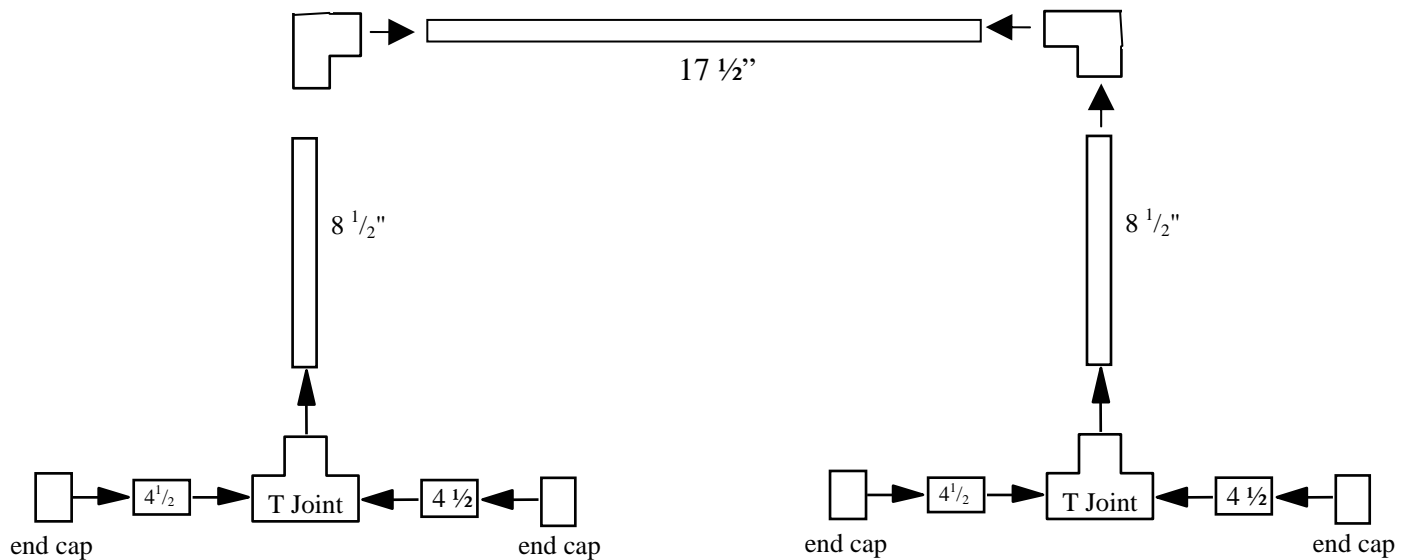

ATEN  
1207 Mellonville Ave  
Sanford, FL 32771  
[www.aten.scps.k12.fl.us](http://www.aten.scps.k12.fl.us)  
(407)688-2201 or (800)328-3678



# PVC Design: Tilting Eye Gaze Frame

Design by Linda J. Burkhardt

## Parts:

½" PVC pipe:

- Two custom length pieces
- Two 12" pieces
- Two 7" pieces
- Four 6" pieces
- Two 3" pieces
- Two 2" pieces

Four ½" PVC T joints

Six ½" PVC elbows

Four ½" PVC end caps

Velcro strips

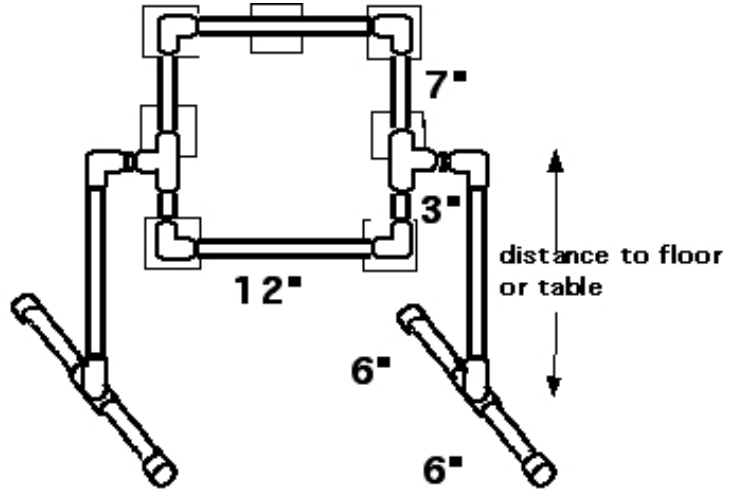

Linda J. Burkhardt  
<http://www.Lburkhardt.com>

## Tools/Supplies

Pliers

PVC Cutters

PVC Cement

PVC Cleaner

Tape Measure

Grease Pencil

## Assembly Instructions:

1. Use the PVC cutters to cut the **Parts** listed above.
2. Assemble the legs as shown below (bottom T joints rotated 90° to see assembly)

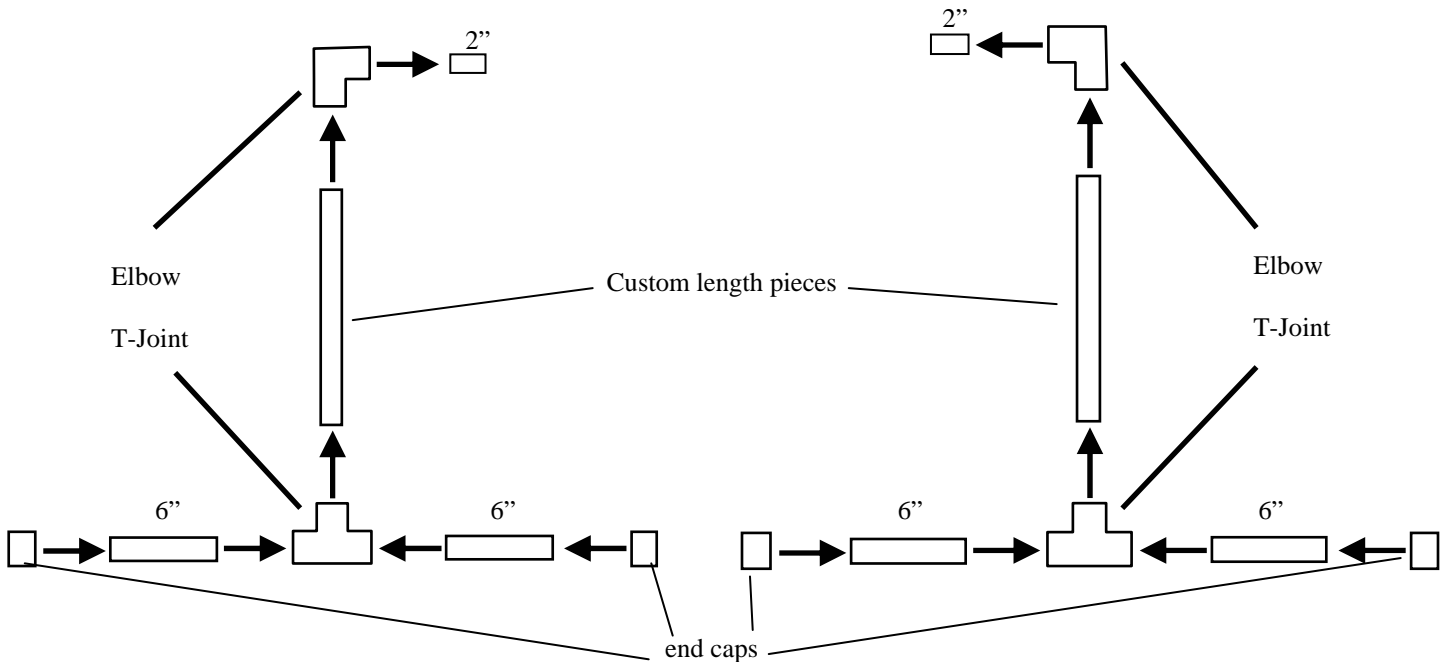

ATEN  
 1207 Mellonville Ave  
 Sanford, FL 32771  
[www.aten.scps.k12.fl.us](http://www.aten.scps.k12.fl.us)  
 (407)688-2201 or (800)328-3678



3. Assemble the eye gaze frame as shown below.

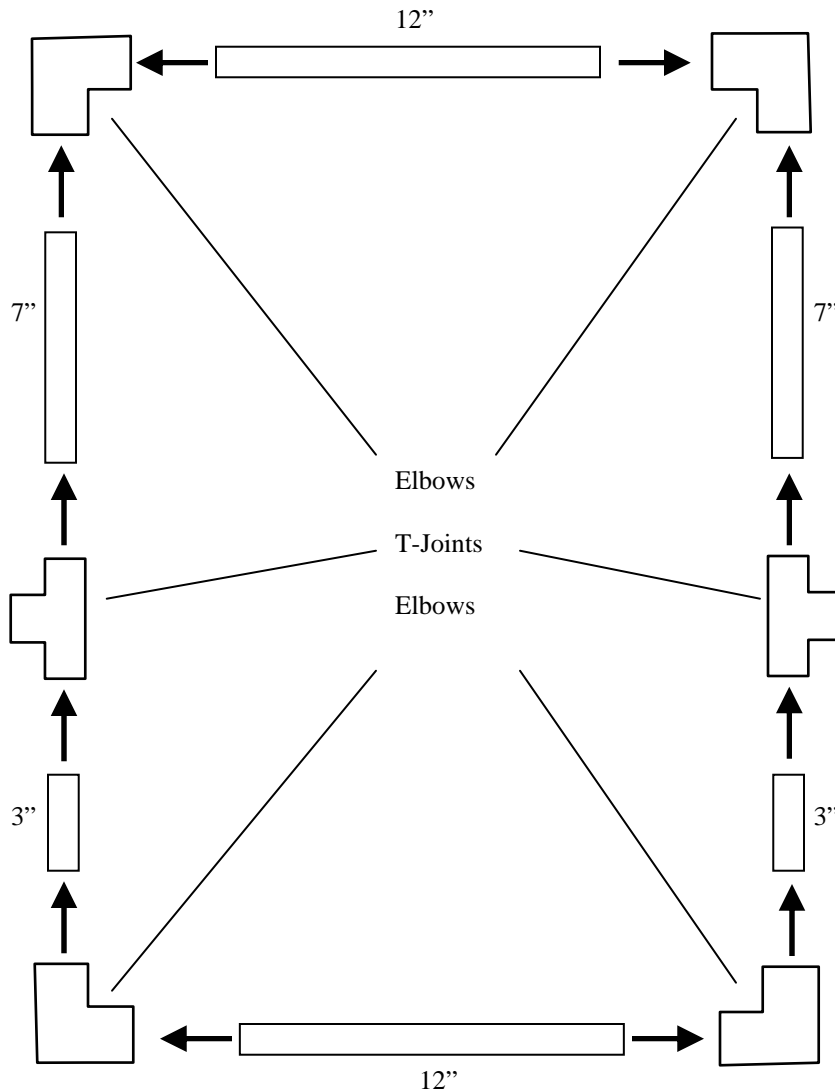

4. Put the legs and eye gaze frame together.
5. You may choose to glue the pieces together. **DO NOT** glue the junction where the legs joined the eye gaze frame. It won't rotate if you do!
6. Apply fuzzy/loop Velcro to one entire side of the eye gaze frame. Additional fuzzy/loop Velcro and pictures can be placed on the back for the adult or partner to read.
7. Apply rough/hook Velcro to the pictures or objects to be placed on the device.

Design by Linda J. Burkhart

More ideas at <http://www.Lburkhart.com>



ATEN  
1207 Mellonville Ave  
Sanford, FL 32771  
[www.aten.scps.k12.fl.us](http://www.aten.scps.k12.fl.us)  
(407)688-2201 or (800)328-3678



# PVC Design: Circle

## Parts:

Five feet of  $\frac{3}{8}$ " Hose\*

Four inches of  $\frac{5}{8}$ " Hose\*

## Tools/Supplies:

PVC cutters

Tape measure

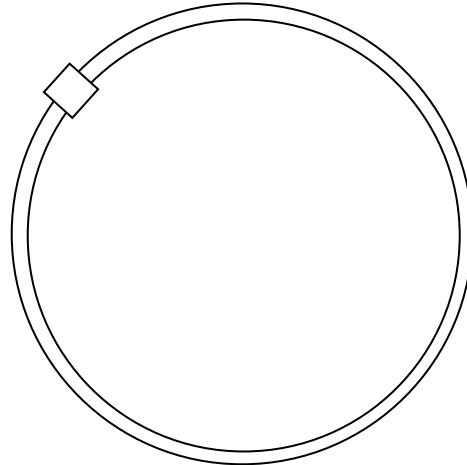

## Assembly Instructions:

1. Use the PVC cutters to cut parts listed above.
2. Join the two ends of the five foot pipe inside the  $\frac{5}{8}$ " hose.

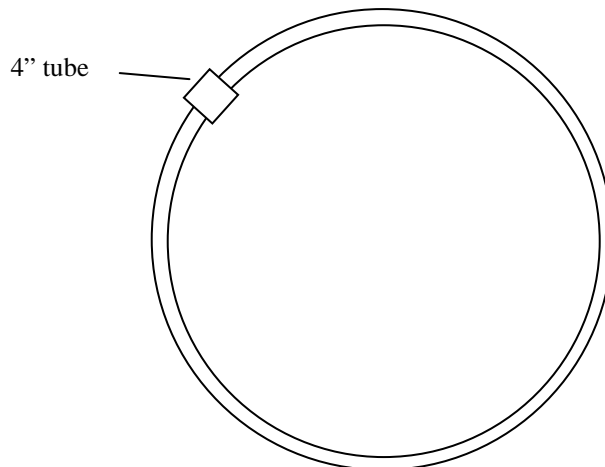

\*The outside diameter of the smaller hose should match the inside diameter of the larger piece of hose.



ATEN  
1207 Mellonville Ave  
Sanford, FL 32771  
[www.aten.scps.k12.fl.us](http://www.aten.scps.k12.fl.us)  
(407)688-2201 or (800)328-3678



# PVC Design: Auditory Feedback Phone

## Parts:

½" PVC Pipe:  
One 2" piece\*  
Two ½" 90° elbows

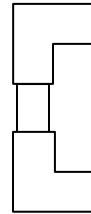

## Tools/Supplies:

PVC Cement

## Assembly Instructions:

1. Connect one elbow to each end of the 2" pipe. Rotate elbows to face the same direction.
- \*Piece of pipe may need to be lengthened to meet individual student's needs

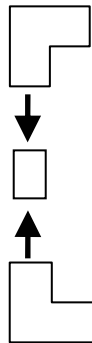

ATEN  
1207 Mellonville Ave  
Sanford, FL 32771  
[www.aten.scps.k12.fl.us](http://www.aten.scps.k12.fl.us)  
(407)688-2201 or (800)328-3678



# PVC Design: Multi-Purpose Easel

Design by Jude Dooley and Susan Heaps

### Parts:

½" PVC pipe:

One 12 ½" piece

One 12" piece

Two 5 ½" pieces

Four 5 ¼" pieces

Four 4 ¾" pieces

Two 2 ½" pieces

Two 1 ½" pieces

Six ½" PVC 90° elbows

Six ½" PVC T joints

Two ½" PVC end caps

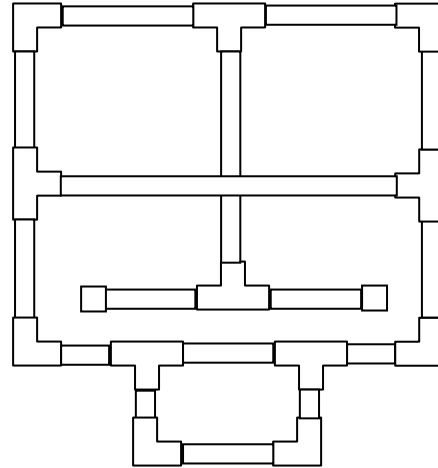

### Tools/Supplies:

Pliers

PVC cutters

PVC cement

PVC cleaner

Grease pencil

Tape Measure

### Assembly Instructions:

1. Use the PVC cutters to cut the pipe into the lengths specified in the **Parts** section on this page.
2. Assemble and cement the frame section as shown below. **DO NOT** Cement the pipe entering the outside edge of the T Joints at the base of the frame. This allows this easel to remain adjustable. This step requires the following pieces of pipe: four 5 ¼" pieces, two 2 ½" pieces, two 4 ¾" pieces, two 1 ½" pieces, and one 12 ½" piece. You will also need six 90° elbow joints and four T joints.

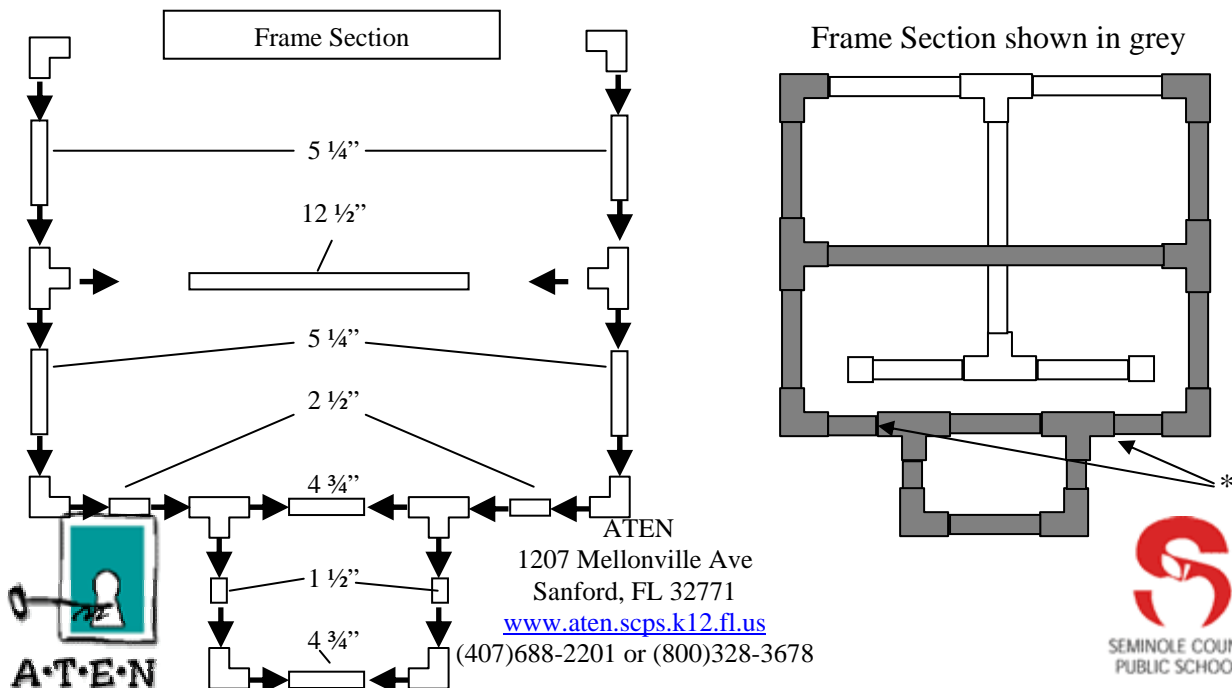

3. Assemble and cement the stand section as shown below\*\*. This step will require the following pieces of pipe: one 12" piece, two 4 3/4" pieces, and two 5 1/2" pieces. You will also need two T joints and two end caps. \*\* DO NOT cement the top part of the stand arm section where the 5 1/2" pieces join with the T joint. This allows the easel angle to remain adjustable.

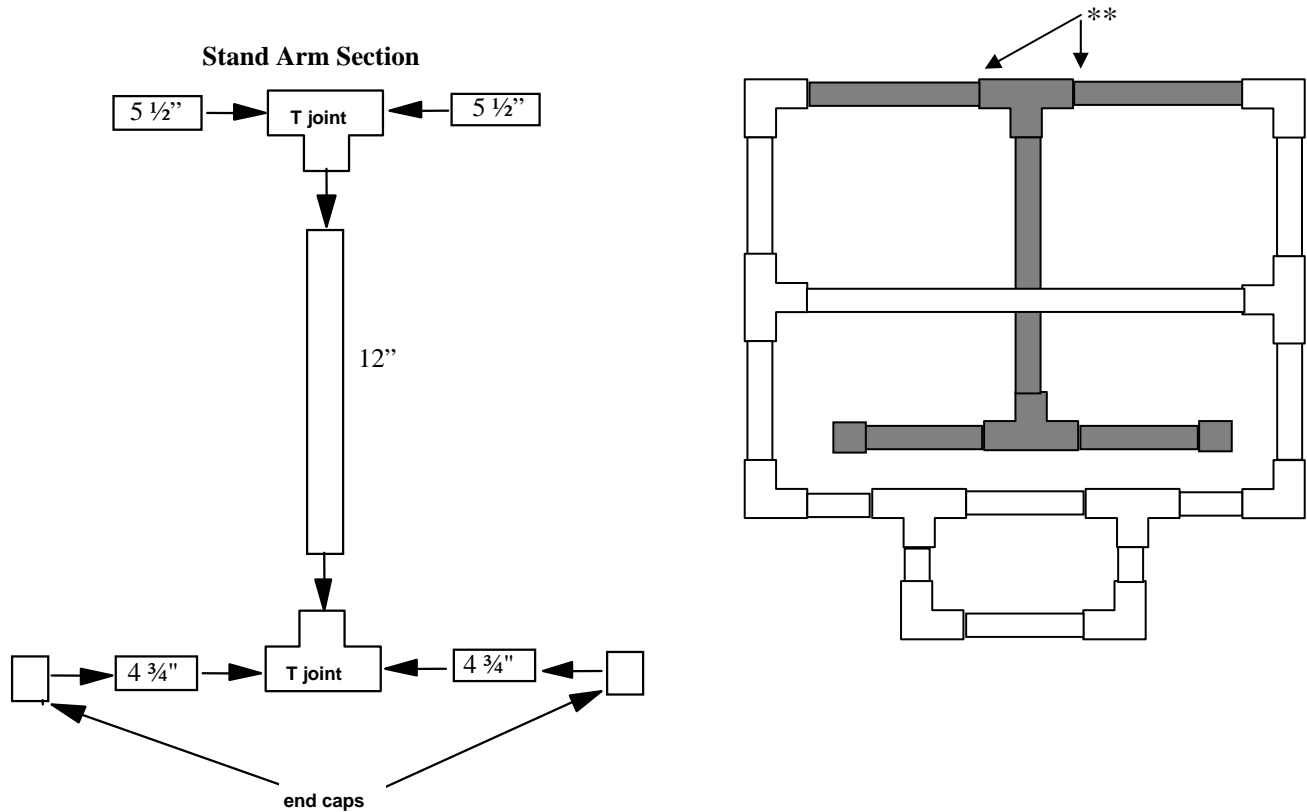

ATEN  
1207 Mellonville Ave  
Sanford, FL 32771  
[www.aten.scps.k12.fl.us](http://www.aten.scps.k12.fl.us)  
(407)688-2201 or (800)328-3678



# PVC Design: Protected Object Display

PVC design by Cathy George based on original wood concept by Carol Goosens' and Pam Elder

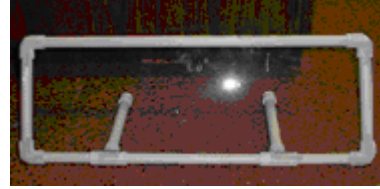

## Parts:

½" PVC pipe:  
One 22" piece  
One 10" piece  
Four 7" pieces  
Two 4 ½" pieces

Four ½" PVC 45° elbows  
Two ½" T Joints  
Two ½" End Caps  
24" X 8" piece of clear acrylic  
Velcro

## Tools/Supplies:

Pliers  
PVC cement  
Tape measure  
PVC cutters  
PVC cleaner

## Assembly Instructions:

3. Use the PVC cutters to cut parts listed above.
4. Assemble the base as shown below.
5. Assemble the vertical frame as shown below.
6. Connect the Base to the Frame. Assembly should be at approximately 75° angle.
7. Use the pliers as necessary to disconnect one joint at a time, apply PVC cleaner and cement, then reassemble the joint.\*\* Do not glue the T Joints to the 4.5" pieces so that the angle can be adjusted as necessary.\*\*
8. Attach the acrylic to the front of the vertical frame using Velcro (female pieces on PVC).

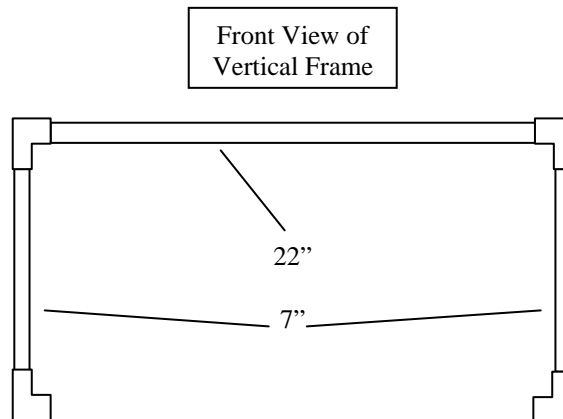
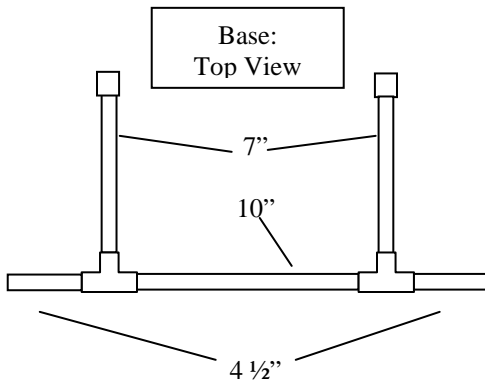

ATEN  
1207 Mellonville Ave  
Sanford, FL 32771  
[www.aten.scps.k12.fl.us](http://www.aten.scps.k12.fl.us)  
(407)688-2201 or (800)328-3678



# PVC Design: Floor Mobile Stand

## Parts:

- 1" PVC pipe:
  - One 22" piece
  - Two 20" pieces
  - Four 5" pieces
- Two 1" PVC T joints
- Two 1" PVC elbows
- Four 1" PVC end caps

## Tools/Supplies

- |              |               |
|--------------|---------------|
| Pliers       | PVC Cutters   |
| PVC Cement   | PVC Cleaner   |
| Tape Measure | Grease Pencil |

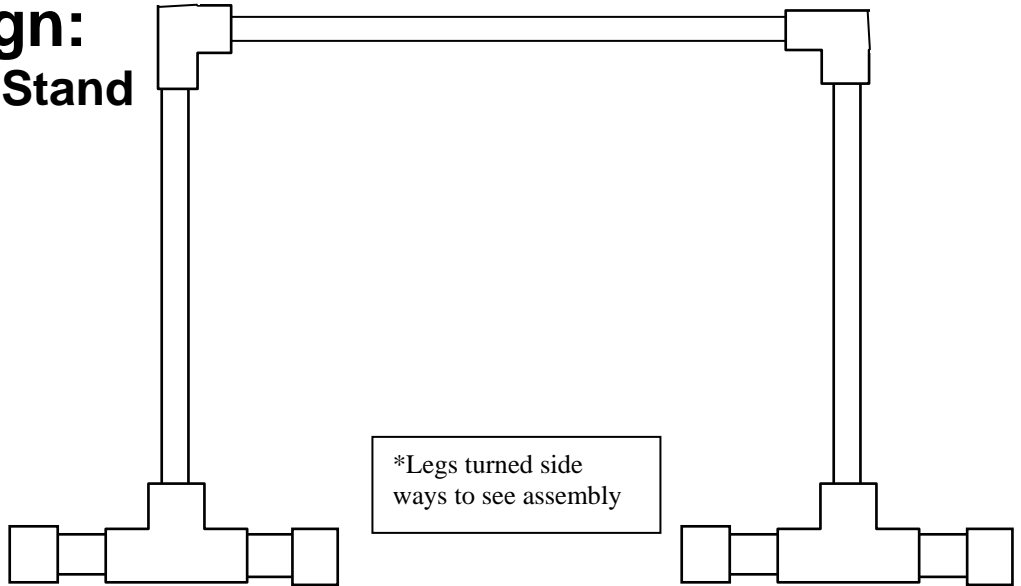

## Assembly Instructions:

1. Use the PVC cutters to cut the **Parts** listed above.
2. Assemble as shown below.
3. Hang toys from upper bar, using neck ties, or other tying methods. Ensure student safety at all times when considering length of tie, toys to be hung at the end (small/moving parts), etc.

### Assemble as Shown Below

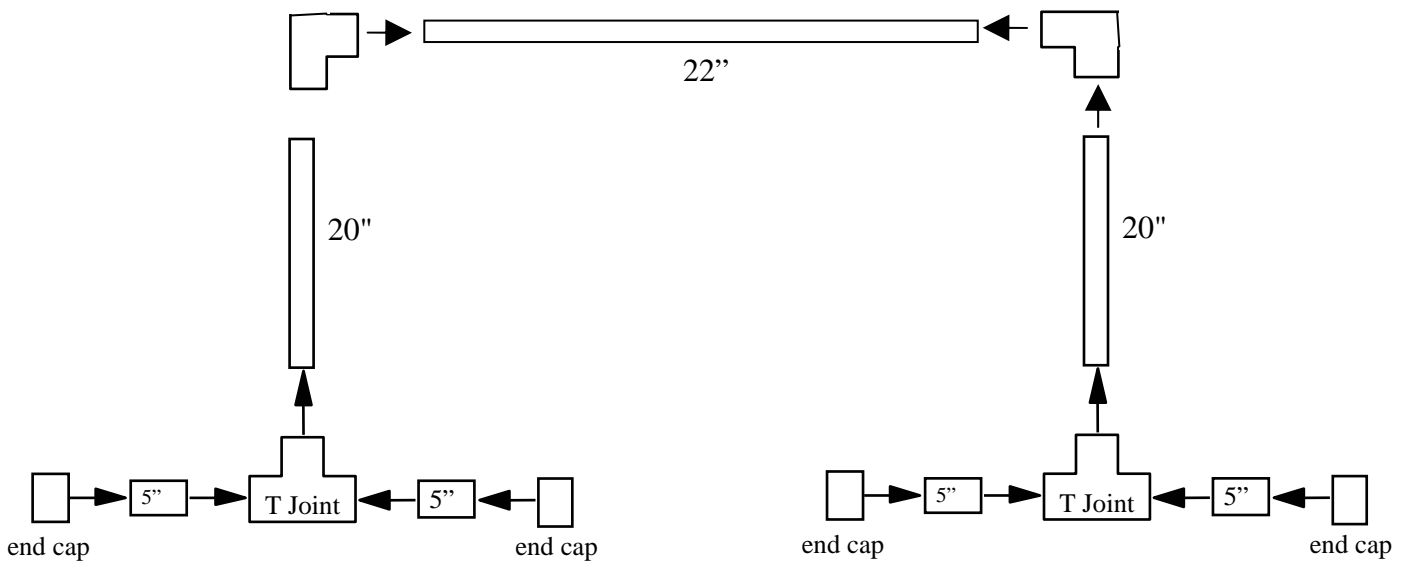

ATEN  
 1207 Mellonville Av.  
 Sanford, FL 32771  
[www.aten.scps.k12.fl.us](http://www.aten.scps.k12.fl.us)  
 (407)688-2201 or (800)328-3678



# PVC Design: 4 Shelf Locker Organizer

Design by Matt Hirn

## Parts:

- 1" PVC pipe:
  - Twelve 14" pieces\*
  - Twelve 12" pieces\*\*
  - Four 6" pieces
  - Four 4" pieces
- Twenty 1" PVC T joints
- Four 1" PVC elbows (90 degree)
- Four 14" X 16" X 1/4" wood

## Tools/Supplies

- |              |               |
|--------------|---------------|
| Pliers       | PVC Cutters   |
| PVC Cement   | PVC Cleaner   |
| Tape Measure | Grease Pencil |

## Assembly Instructions:

1. Use the PVC cutters to cut the **Parts** listed above.
2. Gather two 14" pieces, six 12" pieces, two 6" pieces, two 4" pieces, ten T joints, and two elbows
3. Assemble as pictured to the right.
4. Gather the same pieces as in step 2.
5. Assemble the other side of the locker organizer identically to the picture at right.
6. Use the remaining eight pieces of 14" pipe, connect the two sides.
7. Place the pieces of wood on each shelf.

\*these pieces may need to be longer or shorter based on locker width

\*\*these pieces can be made longer or shorter for different height shelves

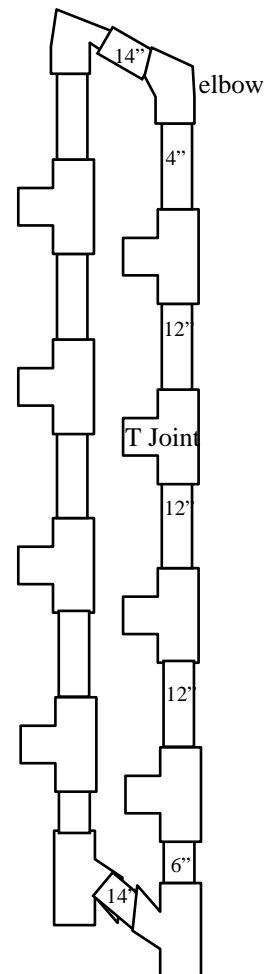
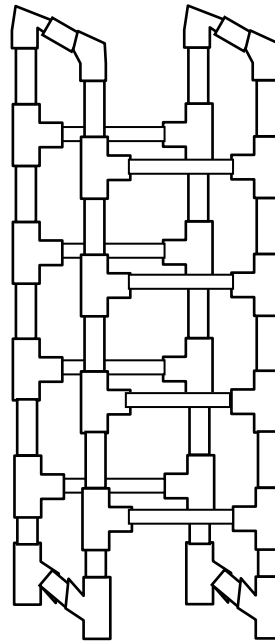

ATEN  
1207 Mellonville Ave  
Sanford, FL 32771  
[www.aten.scps.k12.fl.us](http://www.aten.scps.k12.fl.us)  
(407)688-2201 or (800)328-3678



# PVC Design: Sand/Water Table

Design by Matt Hirn

## Parts:

1 1/2" PVC pipe:

Two 43" pieces

Eight 14" pieces

Four 8" pieces

Four 3 1/2" pieces

Eight 1 1/2" PVC T joints

Four 1 1/2" PVC elbows (90 degree)

Four 1/8" X 3" Toggle Bolts

Four 3/4" washers

Four inches of 1/2" diameter vinyl tubing

1 Sterlite Under Bed Plastic Storage Bin with Lid (44" X 19 3/4" X 6 3/8")

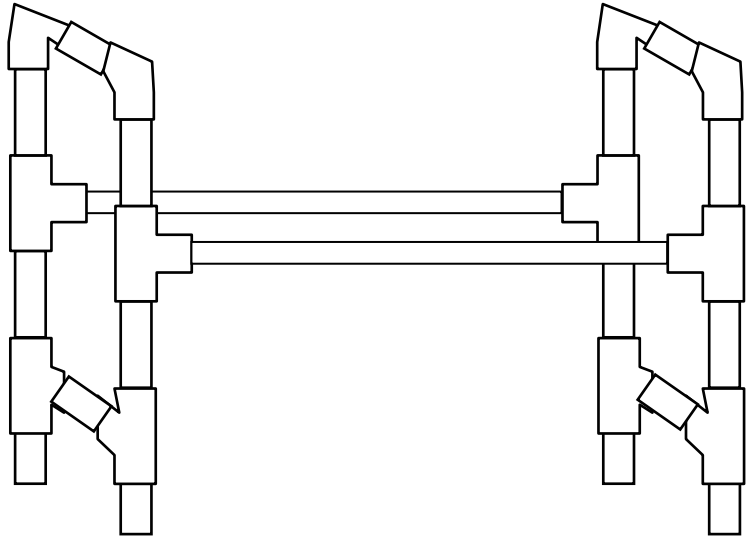

## Tools/Supplies

Pliers

PVC Cutters

Drill

PVC Cement

PVC Cleaner

1/2" Drill bit

Tape Measure

Grease Pencil

## Assembly Instructions:

1. Use the PVC cutters to cut the **Parts** listed above.
2. Gather four 14" pieces, two 8" pieces, two 3 1/2", four T joints, and two elbows.
3. Assemble as pictures to the right.
4. Gather the same pieces as in step 2.
5. Assemble the other side of the water table identically to the picture at right.
6. Use the two 43" pipes to connect the two sides.
7. Place the Plastic Storage Bin on the table, centering it.
8. Drill a hole in the corner of the Plastic storage bin, directly into the upright leg.
9. Place the screw through the plastic bin, then through the vinyl tubing, then place toggle bolt on end and secure to the upright leg.
10. Repeat steps 8 and 9 for the other three legs.

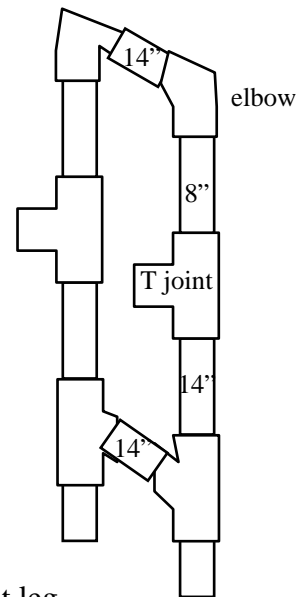

ATEN  
 1207 Mellonville Ave  
 Sanford, FL 32771  
[www.aten.scps.k12.fl.us](http://www.aten.scps.k12.fl.us)  
 (407)688-2201 or (800)328-3678



# SCAMMPERR

## What if we could:

<b>S</b>	Substitute	What else might work instead? Other materials? Another approach?
<b>C</b>	Combine	How about a blend, an alloy? Combine units? Combine purposes?
<b>A</b>	Adapt	What else is like this? What other idea does this suggest? What could I copy or adapt?
<b>M</b>	Modify	Change color, motion, sound, shape? Other changes?
<b>M</b>	Magnify	What to add? What to enhance? Stronger? Longer? Thicker? Heavier?
<b>P</b>	Put to other use	New ways to use it? Other uses if modified? Other places to use? Other people to use it?
<b>E</b>	Eliminate	What to subtract? Smaller? Condensed? Miniature? Lower? Shorter? Lighter? Omit? Streamline? Simplify?
<b>R</b>	Rearrange	Other patterns? Other layouts? Other sequences?
<b>R</b>	Reverse	How about opposites? Turn it backward? Turn it upside-down?



# PVC Resources

Aquatic Eco-Systems Inc.  
1767 Benbow Court  
Apopka, FL 32703  
Phone 407-886-3939  
[www.aquatic-eco.com/products/c1000/c100.htm](http://www.aquatic-eco.com/products/c1000/c100.htm)

Patios To Go, Inc.  
307 North Highway 27  
Clermont FL 34711  
352-243-3220  
[www.patiosotogo.com](http://www.patiosotogo.com)

Utilizing Switch Interfaces with Children who are Severely Physically Challenged  
Carol Goosens' and Sharon Sapp Crain  
Pro Ed  
8700 Shoal Creek Blvd.  
Austin, TX 78757



ATEN  
1207 Mellonville Ave  
Sanford, FL 32771  
[www.aten.scps.k12.fl.us](http://www.aten.scps.k12.fl.us)  
(407)688-2201 or (800)328-3678

